



INVEST IN THE FUTURE



Fabricant français
depuis 1964

Soudage & Coupage

2
0
2
2
C

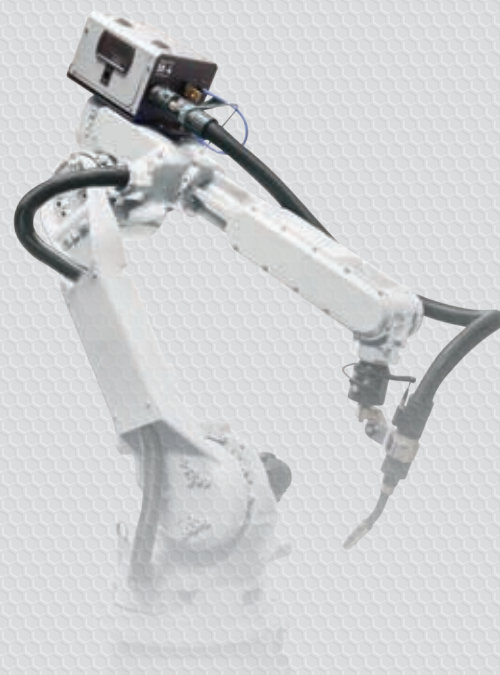

- MMA
- TIG
- MIG-MAG
- COUPAGE PLASMA
- INDUCTION
- SOUDEAGE PAR POINTS
- ARC TIRÉ
- PROTECTIONS
- CONSOMMABLES
- ACCESSOIRES



900 people



125 000 000



55 000 m²
2 factories

Created in 1964, GYS is a French industrial group with 900 employees around the world. Built around continuous investment in Research & Development and in the acquisition of knowledge, the company is now a major player in the design and manufacture of welding machines, battery chargers and car body repair equipment.

“ The market realities are constantly changing and the size of our family business requires us to quickly adapt to new contexts and new challenges.

We are convinced that our future is closely linked to the future of our partners. This is why we do everything in our power to understand what distributors and users expect from us and what challenges they face every day. To support them in facing these challenges, we wish to become and remain their privileged partner on the path we will travel together. ”

Bruno Bouygues,
C.E.O.



Nicolas & Bruno Bouygues

A worldwide coverage

136 countries



visit with
Youtube

INVEST IN THE FUTURE

FR

Créé en 1964, GYS est un groupe industriel français regroupant plus de 900 collaborateurs dans le monde. Fort d'un centre de recherche de premier plan, GYS est un acteur majeur dans la conception et la fabrication d'équipements de soudage, de chargeurs de batteries et de systèmes de réparation carrosserie.

Les nouvelles réalités du marché sont en perpétuel changement et la taille de notre entreprise familiale nous impose une adaptation rapide aux nouveaux contextes et à leurs enjeux.

Nous sommes convaincus que notre avenir est étroitement lié à celui de nos clients. Pour cela, nous mettons tout en oeuvre pour comprendre ce que les distributeurs et les utilisateurs attendent de nous, savoir à quels défis ils font face et voir dans quelle mesure nous pouvons leur permettre de les relever afin de devenir et rester leur partenaire privilégié pour le chemin que nous avons à parcourir ensemble.

DE

GYS wurde 1964 gegründet und ist ein französisches Familienunternehmen mit mehr als 900 Mitarbeitern auf der ganzen Welt. Dank einem erstklassigen Forschungszentrum ist GYS ein wichtiger Akteur in der Entwicklung und Herstellung von Schweißgeräten, Batterieladegeräten und Karosseriereparatursystemen.

Neue Marktbedingungen sind in fortwährender Veränderung und die Größe unseres Familienunternehmens veranlasst eine rasche Anpassung an neue Umstände und an ihre Herausforderungen.

Wir sind überzeugt, dass unsere Zukunft eng mit der unserer Kunden verbunden ist. Dafür setzen wir all unser Können ein, um zu verstehen, was die Händler und Anwender von uns erwarten, welchen Herausforderungen sie gegenüberstehen und um zu schauen, in welchem Maße wir sie unterstützen können, damit wir ihr bevorzugter Partner werden und bleiben auf dem Weg, den wir gemeinsam beschreiten.

IT

Nato nel 1964, GYS è un gruppo industriale francese che raggruppa oltre 900 collaboratori nel mondo. Forte di un centro di ricerca di grande importanza, GYS è uno dei maggiori protagonisti nella progettazione e fabbricazione di apparecchiature per la saldatura e il taglio, di caricabatterie booster e avviatori e sistemi di riparazione delle carrozzerie.

Le realtà del mercato sono in continuo cambiamento e richiedono risposte immediate. Le dimensioni della nostra impresa familiare consentono un adattamento rapido ai nuovi contesti e alle loro problematiche.

Siamo convinti che il nostro futuro sia strettamente legato a quello dei nostri clienti. Per questo noi mettiamo il massimo impegno per capire quello che i distributori e i loro clienti/utilizzatori si aspettano da noi, quali sfide devono affrontare e come possiamo aiutarli per farli crescere, per diventare e restare loro partner di riferimento per proseguire insieme sul cammino del successo.



GYS FRANCE Laval	GYS GERMANY Aachen	GYS U.K. Rugby	GYS CHINA Shanghai	GYS ITALIA Venezia	GYS IBERICA Madrid
🕒 1964 👤 × 650	🕒 2006 👤 × 75	🕒 2008 👤 × 40	🕒 2004 👤 × 110	🕒 2015 👤 × 25	🕒 2022 👤 × 6

Partners





GYS ACADEMY

Training centre
 Centre de formation agréé
 Trainingcenter für Profis
 Centro di formazione dedicato ai professionisti

Ref. 52 53 0068153

3 catalogues

3 200+ references



Welding & Cutting



Car Body Welding Systems



Chargers, Boosters & Starters

MMA

Traditional

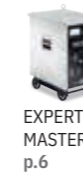

EXPERT MASTER p.6

Inverter



GYSARC p.7



GYSMI p.10



PROGYS p.12



EXAGON p.15



Complete packs p.17



Accessories & consumables p.18

TIG

DC



PROTIG DC p.22



TITAN p.24



EXATIG ORBITIG p.25

AC/DC



PROTIG AC/DC p.26



TITANIUM p.28

Complete packs p.30

Accessories & consumables p.32

MIG/MAG

Traditional



SMARTMIG p.34



MONOGYS TRIMIG p.36



PROMIG p.38

Inverter



EASYMIG p.44



MULTIPEARL p.46



MULTIWELD p.48

NEW



EXAGON p.50

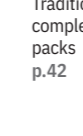

MAGYS p.40

NEW



SMARTFEED SAM / PLC / ROBOT / COBOT p.62

Accessories & consumables p.66

Traditional complete packs p.42

Inverter complete packs p.60

SPOT WELD



PORTASPOT p.70



DRAWN ARC



ARCPULL p.71



PLASMA



EASYCUT p.74



CUTTER p.76



NEOCUT p.77

Complete packs p.79

Accessories & consumables p.80

INDUCTION



POWERDUCTION p.82

Accessories & consumables p.85

METROLOGY



CALIWEED Accessories p.86

+ MORE

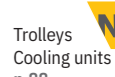

Trolleys Cooling units p.88

Cable Clamps Accessories p.90



Protections Helmets p.96

Electric soldering & gas welding p.104

Working lights p.106

Marketing p.107

Advanced R&D

90



Metal work
Tôlerie
Blechbearbeitung



Painting & marking
Peinture & marquage
Lackierstraße



Electronics
Électronique
Elektronik



Mechanical
Mécanique
CNC-Bearbeitung



Transformers
Transformateurs
Transformatoren



Cable work
Filerie
Kabelkonfektionierung

Assembly
Montage/tests
Montage

100%
in house
production



EXPERT / MASTER

SMAW MMA TRADITIONAL



10/25 mm² Ø 9 mm
10/25 mm² Ø 9 mm
Master 250 : 35/50 mm² Ø 13 mm
Master 350 & 450 50/70 mm² Ø 13 mm

PROFESSIONAL AC

EXPERT 110	EXPERT 130	EXPERT 220 DV
230 V • 1 ~	230 V • 1 ~	230V 1~ + 400V 2~
100A 2+2.5 mm	130A 2+3.2 mm	220A 2+4 mm
062375 115,00 €HT	015029 161,00 €HT	015128 244,00 €HT

INDUSTRIAL DC

MASTER 250	MASTER 350	MASTER 450
400 V • 3 ~	400 V • 3 ~	400 V • 3 ~
220A 2.5+4 mm	320A 3.2+6 mm	400A 3.2+8 mm
no accessories, : 014930 1 056,00 €HT	no accessories, : 014954 1 375,00 €HT	no accessories, : 014916 1 588,00 €HT

OPTIONS MASTER

MMA KITS	kit	A	TIG		MMA		mm ²	mm ²	Ref.
			L m	model	L m	model			
	5	300	4	HELIX T300.50	4	CROCOT400.70	35	35/50	047341 158,00 €HT
	6	300	4	SHARK X400.70	4	CROCOT400.70	35	35/50	038295 161,00 €HT
	7	500	5	SHARK X500.95	4	TYREX 600.95	50	35/50	047419 238,00 €HT



GYSARC

SMAW MMA INVERTER

NEW ON DEMAND



10/25 mm² Ø 9 mm
10/25 mm² Ø 9 mm
10/25 mm² Ø 9 mm
10/25 mm² Ø 9 mm
10/25 mm² Ø 9 mm

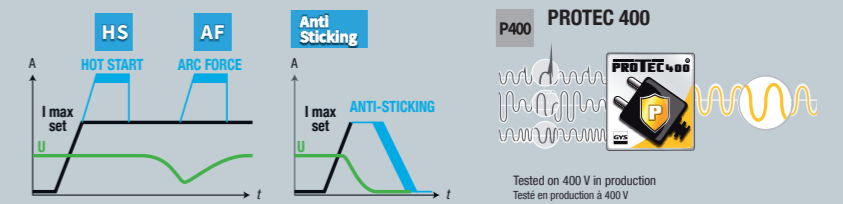

230 V • 1 ~

GYSARC 80	GYSARC 100	GYSARC 120	GYSARC 160	GYSARC 200
230 V • 1 ~	230 V • 1 ~	230 V • 1 ~	230 V • 1 ~	230 V • 1 ~
80 A 1.6+2.5 mm	100 A 1.6+2.5 mm	120 A 1.6+3.2 mm	160 A 1.6+4 mm	200 A 1.6+5 mm
1.6 m, 10 mm ² + 1.6 m, 10 mm ² 065505 161,00 €HT	1.6 m, 10 mm ² + 1.6 m, 10 mm ² 071551 174,00 €HT	1.6 m, 10 mm ² + 1.6 m, 10 mm ² 013704 211,00 €HT	1.6 m, 16 mm ² + 1.6 m, 16 mm ² 014664 245,00 €HT	1.6 m, 16 mm ² + 1.6 m, 16 mm ² 065512 338,00 €HT

CE NORM EN60974-1	MADE IN P.R.C	50/60 Hz	A	I ₂	EN60974-1 (40°C)			U _o	cm / kg	Protected & compatible power generator (+/-15%)		cm / kg
					I (60%)	X% (I2 max)	100%			kW	kVA	
EXPERT 110	230V 1~	8	75 + 100 AC	—	—	—	48	47 × 24 × 32 / 13	6.5 kW	11 kVA	28 × 17 × 26 / 13	
EXPERT 130	230V 1~	10	55 + 130 AC	53 A	10 %	—	48	47 × 24 × 36 / 18	6.8 kW	11.3 kVA	39 × 19 × 32 / 18	
EXPERT 220 DV	230V 1~	25	65 + 220 AC	90 A	10 %	—	48	51 × 38 × 30 / 23	12 kW	20 kVA	42 × 37 × 25 / 23	
	400V 2~	13										
MASTER 250	400V 3~ (50 Hz)	15	90 + 220 DC	167 A	35 %	126 A	40-68	65 × 75 × 44 / 86	9.9 kW	14.1 kVA	64 × 75 × 42 / 86	
MASTER 350	400V 3~ (50 Hz)	32	140 + 320 DC	243 A	35 %	149 A	60-80	68 × 75 × 58 / 132	16.4 kW	23.4 kVA	68 × 75 × 58 / 132	
MASTER 450	400V 3~ (50 Hz)	32	140 + 400 DC	306 A	35 %	234 A	60-85	57 × 85 × 65 / 136	22.5 kW	32.1 kVA	57 × 85 × 65 / 136	

CE NORM EN60974-1	MADE IN GYS CHINA	50/60 Hz	A	I ₂	INTEGRATED TECHNOLOGY			X% GYS (20°C)	EN60974-1 (40°C)			U _o	cm	kg	
					P400	HS	AF		Anti sticking	I (60%)	X% (I2 max)				100%
GYSARC 80	1	230V	16	10+80	—	■	■	■	40% @ 80 A	50 A	20%	35 A	63 V	13 × 22 × 10	2
GYSARC 100	1	230V	16	10+100	—	■	■	■	25% @ 100 A	50 A	14%	35 A	63 V	13 × 22 × 10	2
GYSARC 120	1	230V	16	10+120	—	■	■	■	40% @ 120 A	70 A	20%	55 A	63 V	15 × 23 × 10	2.7
GYSARC 160	1	230V	16	10+160	—	■	■	■	20% @ 160 A	85 A	10%	70 A	63 V	15 × 23 × 10	2.9
GYSARC 200	1	230V	32	20+200	■	■	■	■	20% @ 200 A	100 A	10%	80 A	64 V	18 × 30 × 13	4.7

GYSARC

MMA • INVERTER



GYSARC

SMAW MMA INVERTER

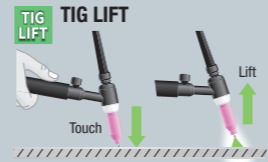
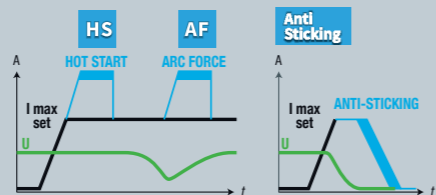

VRD inside

Voltage Reduction Device

Software & Hardware protection

VRD ON VRD OFF

	U ₀ =	
220 FV	14 V	80/86 V
300 TRI	20 V	83 V
400 TRI	20 V	84 V

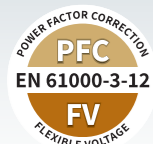

4 in 1

- 1 MMA
- 2 TIG DC LIFT
Torches & consumables p. 33
- 3 GOUGING
Accessories p. 18
- 4 TIG HF • Exatig



details p.25

110 • 230 V • 1 ~

400 V • 3 ~

GYSARC 220 FV CEL



110 + 230 V • 1 ~
220 A ⚡ Ø 1.6+5 mm

PFC POWER FACTOR CORRECTION

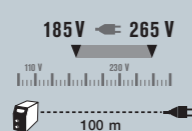

FV FLEXIBLE VOLTAGE

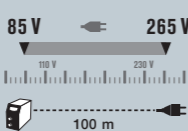

P400 PFC FV

VRD inside HS AF CEL cellulosic

Dynamic arc system MMA PULSE

TIG LIFT TIG PULSE AD IP 23

2 m, 25 mm² + 2 m, 25 mm²
065529 **863,00 €HT**

GYSARC 300 TRI



400 V • 3 ~
300 A ⚡ Ø 1.6+6.3 mm

VRD inside HS AF Anti Sticking CEL cellulosic

TIG LIFT IP 23 GOUGING

no accessories:
064959 **1 275,00 €HT**

GYSARC 400 TRI



400 V • 3 ~
400 A ⚡ Ø 1.6+6.3 mm

VRD inside HS AF Anti Sticking CEL cellulosic

TIG LIFT GOUGING IP 23

no accessories:
013551 **1 700,00 €HT**

OPTIONS



Pince de gougeage - Gouging Torch
- Fugenhobel-Zange
1 000 A
041516 **329,00 €HT**



Adaptateur gougeage
- Gouging clamp adaptor
- Fugenhobeladapter
70 mm² - 5 m
040670 **186,00 €HT**



Électrodes de gougeage - Gouging
- Electrodes - Fugenhobelektrode
- Electrodes de carbono
Ø 5 mm (x50) 069756 **26,00 €HT**
Ø 6.4 mm (x50) 086081 **32,00 €HT**
Ø 8 mm (x50) 086098 **36,00 €HT**

OPTIONS

Filter kit
046580 **50,00 €HT**



Hand remote control
RC-HA1
8 m
045675



JOB SITE XL
600 x 1150 x 584 mm
039568 **423,00 €HT**



MMA KIT 7
500 A
047419
238,00 €HT



L m	model	L m	model	mm ²	mm ²
5	SHARK X500.95	4	TYREX 600.95	50	35/50

TIG torch kit SR17 V (valve)
4 m, 35/50 mm², Ø13
044401 **108,00 €HT**



GYSARC	MADE IN GYS CHINA	~	50/60 Hz	A	A	INTEGRATED TECHNOLOGY							X ₂ GYS (20°C)	EN60974-1 (40°C)			U ₀	cm / kg	Protected & compatible power generator (+/-15%)	
						P400	VRD	HS	AF	Anti sticking	CEL	TIG Lift		IP 23	I (60%)	X% (I2 max)				100%
GYSARC 220 FV CEL	1	230V	16	10+220	■	■	■	■	■	■	■	■	40% @ 220 A	130 A	20%	100 A	86 V	42 × 21 × 35/10.5	8.5 kW	12.5 kVA
			32	10+120	■	■	■	■	■	■	■	■	■	60% @ 120 A	90 A	30%	70 A	80 V		
GYSARC 300 TRI	3	400V	16	20+300	—	■	■	■	■	■	■	■	100% @ 300 A	300 A	60%	230 A	83 V	54 × 46 × 28/26	10 kW	12.5 kVA
GYSARC 400 TRI	3	400V	32	20+400	—	■	■	■	■	■	■	■	100% @ 400 A	400 A	60%	350 A	84 V	58 × 52 × 30/38	30 kW	36 kVA



9

GYSARC

MMA • INVERTER

8

PORTE-ÉLECTRODES - Electrode holders - Elektrodenhalter - Portaelectrodos - Elektrodenhouder - Porta electrodos

HELIX, VESTALE & PYTHON



	HELIX T200.25	HELIX T300.50	HELIX T400.70	HELIX PRO T400.70	HELIX PRO T500.95	PYTHON T500.95	VESTALE T500.95
A	200 A	300 A	400 A	400 A	500 A	500 A	500 A
⊗ max	25 mm ²	50 mm ²	70 mm ²	70 mm ²	95 mm ²	95 mm ²	95 mm ²
A (X%)	200A (35%) 150A (60%)	300A (35%) 250A (60%)	400A (35%) 300A (60%)	400A (35%) 300A (60%)	500A (35%) 400A (60%)	500A (35%) 400A (60%)	500A (35%) 400A (60%)
↔ min/max	2 > 3.2 mm	2 > 4 mm	2 > 6.3 mm	1.6 > 6.3 mm	2 > 8 mm	1.6 > 8 mm	2 > 8 mm
x1 (vrac)	043497 11,00 € HT	038288 16,10 € HT	043732 22,00 € HT	039919 54,00 € HT	039902 66,00 € HT	038011 22,00 € HT	038097 60,00 € HT

SHARK



	SHARK X200.35	SHARK PRO C300.35	SHARK X300.50	SHARK X400.70	SHARK C400.95	SHARK X500.95	SHARK C600.120
A	200 A	300 A	300 A	400 A	400 A	500 A	600 A
⊗ max	35 mm ²	35 mm ²	50 mm ²	70 mm ²	95 mm ²	95 mm ²	120 mm ²
A (X%)	200A (35%) 150A (60%)	300A (35%) 250A (60%)	300A (35%) 250A (60%)	400A (35%) 300A (60%)	400A (35%) 300A (60%)	500A (35%) 400A (60%)	600A (35%) 500A (60%)
↔ min/max	1.6 > 4 mm	1.6 > 4 mm	1.6 > 5 mm	2 > 6.3 mm	2 > 6.3 mm	2 > 8 mm	2 > 10 mm
x1 (vrac)	043503 9,00 € HT	039926 55,00 € HT	043510 14,00 € HT	038004 20,00 € HT	043725 20,00 € HT	043718 19,00 € HT	046542 30,00 € HT
x1 (blister)	043602 9,00 € HT		043701 14,00 € HT				
♻️	x 50 043558 378,00 € HT		x 25 043565 309,00 € HT				

PORTE-ÉLECTRODES ASSEMBLÉS

- Electrode holder kits
- Montierter Elektrodenhalter



A	↔	L (m)	⊗ (mm ²)	↔ (mm ²)	∅	Ref.
150/200	SHARK X200.35	4	16	10/25	9	x1 043848 46,00 € HT
200	SHARK X200.35	4	25	35/50	13	x1 043855 63,00 € HT
300	SHARK X300.50	4	35	35/50	13	x1 043862 86,00 € HT
500	SHARK X500.95	4	50	35/50	13	x1 043879 116,00 € HT
600	SHARK C600.120	5	70	35/50	13	x1 047006 231,00 € HT

KIT POUR POSTES MMA (CÂBLES + PINCES + CONNECTEURS)

- MMA kits (Electrode holder + earth clamp + cable/connectors)
- Kit MMA (cables + pinzas + conectadores)
- MMA-Sets (Elektrodenhalter + Masseklemme montiert)



A	↔	L (m)	model	L (m)	model	⊗ (mm ²)	↔ (mm ²)	∅	Ref.
kit 1	150/200 A	1.6	SHARK X200.35	2	CROCO A200.35	16	10/25	9	x1 047372 57,00 € HT
kit 2	200 A	1.6	SHARK X200.35	2	CROCO A200.35	25	10/25	9	x1 047389 74,00 € HT
kit 3	200 A	3	SHARK X300.50	3	CROCO T400.70	25	10/25	9	x1 047396 97,00 € HT
kit 4	200 A	3	SHARK X300.50	3	CROCO T400.70	25	35/50	13	x1 047402 103,00 € HT
kit 5	300 A	4	HELIX T300.50	4	CROCO T400.70	35	35/50	13	x1 047341 158,00 € HT
kit 6	300 A	4	SHARK X400.70	4	CROCO T400.70	35	35/50	13	x1 038295 161,00 € HT
kit 7	500 A	5	SHARK X500.95	4	TYREX 600.95	50	35/50	13	x1 047419 238,00 € HT
kit 8	600 A	5	SHARK C600.120	4	TYREX 600.95	70	35/50	13	x1 047426 359,00 € HT

OPTION TIG LIFT - TIG torch with valve - WIG-Schlauchpaket

TIG torch kit SR17V (valve)
4 m

for 10/25 mm², Ø9:
✓ GYSMI 130P / 160P / 200P / E160 / E163 / E200 FV
✓ PROGYS 180A / 183E / 200A PFC
044425 106,00 € HT

for 35/50 mm², Ø13:
✓ GYSARC 220 FV CEL / 300TRI / 400TRI
✓ PROGYS 200E FV CEL / 220E FV CEL / 250 TRI / CEL 250 TRI / FLEX 280 CEL / EXAGON 400
044401 108,00 € HT



GUIDE CÂBLE DE SOUDAGE

- Welding cable hitch - Schweißkabelführung

044234
9,00 € HT



SUPPORT PORTE-ÉLECTRODES MAGNÉTIQUE

- Electrode holder stand with magnetic base - magnetischer Elektrodenhalter

038028 10,00 € HT



GOUGEAGE - Gouging - Fugenhobeln



Pince de gougeage - Gouging Torch
- Fugenhobel-Zange, 1000 A
041516 329,00 € HT



Câble pour pince de gougeage
- Cable for gouging torch
- Anschlusskabel für Fugenhobel-Brenner
70 mm² - 5 m
040670 186,00 € HT



Électrodes de gougeage - Gouging - Electrodes
- Fugenelektrode - Electrodes de carbono

∅ 5 mm (x50)	069756 26,00 € HT
∅ 6.4 mm (x50)	086081 32,00 € HT
∅ 8 mm (x50)	086098 36,00 € HT

MARTEAUX À PIQUER - Chipping Hammers - Schlaghammer - Martillos



HAMMER 260 260 mm, 240 g (x1) 044159 4,00 € HT	HAMMER 285 285 mm, 425 g (x1) 044128 6,00 € HT	HAMMER 370 PRO Premium 270 mm / 370 g (x1) 066663 8,00 € HT	HAMMER 290 PRO Premium 290 mm, 465 g (x1) 044135 8,00 € HT	HAMMER 320 PRO Premium 320 mm, 425 g (x1) 044142 24,00 € HT
---	---	---	--	---

BROSSES - Wire brushes - Bürsten - Spazzola - Cepillos



	↔	∅	Acier - Steel - Stahl - Acero - Staal - Aço	Inox - Stainless - Edelstahl
A	4	—	(x1) 044241 2,00 € HT (x24) 044265 49,00 € HT	(x1) 044258 5,00 € HT (x24) 044272 99,00 € HT
B	3	—	(x1) 044227 2,10 € HT	(x1) 044289 2,00 € HT
C	2	•	(x1) 044166 3,00 € HT	—
D	—	—	(x1) Laiton - Brass 038073 4,10 € HT (x1) Zinc 038080 4,00 € HT	—

ACIER/STEEL

6013 - Rutile - Rutile - Rutilos - Rutielen - Rútilos

Normes - Norms - Normen - Norma
AWS A 5.1 : E 6013
EN ISO 2560-A : E 420 RC 11
DB - Zulassung-Nr : 10.064.02

Position

Polarity (-)
Mechanic
Re : 440 Mpa
Rm : 540 Mpa
A 5 d : 24%
Impact energy : 0°C 50j



Ø	Length	Diameter	Diagram		Code	kg
			Diagram 1	Diagram 2		
A	300	210			085114 25.00 EHT	1.65
	350	155			085121 16.20 EHT	2.08
	350	110			085138 13.20 EHT	2.11
	350	70			085145 13.40 EHT	2.09
B	350	47			085152 14.40 EHT	2.21
	350	355			085022 35.20 EHT	4.82
	350	230			085039 27.20 EHT	4.46
	350	165			085046 29.20 EHT	4.85
350	110			085053 30.20 EHT	5.39	



Ø	Length	Diameter	Diagram		Code	kg
			Diagram 1	Diagram 2		
Ø 1.6	17				084315 3.40 EHT	
	50				084414 6.50 EHT	
Ø 2.0	13				084322 2.20 EHT	
	50				084421 6.20 EHT	
Ø 2.5	11				084339 2.20 EHT	
	50				084438 6.00 EHT	
Ø 3.2	9				084346 2.20 EHT	
	50				084445 9.40 EHT	
Ø 4.0	8				084353 3.40 EHT	
	50				084452 14.10 EHT	



Ø	Length	Diameter	Diagram		Code	kg
			Diagram 1	Diagram 2		
Ø 2.5	350	75			081598 13.00 EHT	1.5
		252			086005 34.00 EHT	4.6
Ø 3.2	350	54			081604 13.40 EHT	1.7
		172			086012 34.00 EHT	5
Ø 4.0	350	117			086029 37.40 EHT	5

7018 (low hydrogen) - Basic - Basisch - Básicos - Basis

Normes - Norms - Normen - Norma
AWS A 5.1 : E 7018-1
ISO 2560-A : E 42 4B 42 HS

Position

Polarity (+/-)
Mechanic
Re : 470 Mpa
Rm : 560 Mpa
A 5 d : 26%
Impact energy : -40°C 60j
H2-H5 (5 ml/100 g)



Ø	Length	Diameter	Diagram		Code	kg
			Diagram 1	Diagram 2		
Ø 2.0	300	13			A 066717 4.30 EHT	
		10			A 066724 4.00 EHT	
Ø 2.5	350	210			B 081918 44.30 EHT	
		84				081970 19.20 EHT
Ø 3.2	350	7			A 066731 4.20 EHT	
		130			B 081925 42.10 EHT	
Ø 4.0	350	54				081987 19.00 EHT
		6			A 066748 4.20 EHT	
Ø 4.0	350	96			B 081932 43.30 EHT	
		38				081994 19.50 EHT

ALUMINIUM - Aluminium - Aluminio

4043

Normes - Norms - Normen - Norma
AWS A 5.3 : E 4043
ISO 18273 : Al 4043 A
DIN 1732 : EL-AISI5

Position

Polarity (+)
Mechanic
Re : 100 MPa
Rm : 200 MPa
A 5 d : 5%
Impact energy : -20°C 20j



Ø	Length	Diameter	Diagram		Code	kg
			Diagram 1	Diagram 2		
Ø 2.5	7				073708	-
Ø 3.2	5				084803 6.00 EHT	-
Ø 3.2	147				081949 114.00 EHT	2

ACIER INOXYDABLE - Stainless Steel - Edelstahl

312R



Normes - Norms - Normen - Norma
AWS 5.4 / E312-16
EN ISO 3581-A / E 29 9 R

Position

Polarity (+)

Mechanic
Re : 450 MPa
Rm : 680 MPa
A 5 d : 25%
Impact energy : -20°C 60j

Dissimilar Electrodes - Maintenance & Repair

Ø	Length	Diameter	Code	kg
Ø 2.0	84		073661	
Ø 2.5	54		081475 41.50 EHT	
Ø 3.2	28		081468 39.00 EHT	
Ø 4.0	19		073678	

308L



Normes - Norms - Normen - Norma
AWS A 5.4 : E 308 L-17
EN ISO 3581-A : E 19 9L R32

Position

Polarity (+)

Mechanic
Re : 380 MPa
Rm : 600 MPa
A 5 d : 38%
Impact energy : -20°C 60j

Ø	Length	Diameter	Code	kg
Ø 2.0	14		073692	
Ø 2.5	10		082328 8.00 EHT	

316L



Normes - Norms - Normen - Norma
AWS A 5.1 : E 316 L-16
EN ISO 3581-A : E 19 12 3L R31
DIN 8556 : E 19 12 3 NCR23

Position

Polarity (+)

Mechanic
Re : 350 MPa
Rm : 490 MPa
A 5 d : 30%
Impact energy : -20°C 60j

Ø	Length	Diameter	Code	kg
Ø 1.6	14		073685	
Ø 2.0	12		082359 7.00 EHT	
Ø 2.5	10		082335 8.20 EHT	
Ø 2.5	30		081499 24.50 EHT	
Ø 3.2	8		082342 11.00 EHT	
Ø 3.2	25		081482 34.00 EHT	
Ø 3.2	600 (20 kg)		081963 811.00 EHT	

FORTE - Cast Iron - Gusselektroden - Hierro Colado - Gießtizer - Ferro Fundido



Normes - Norms - Normen - Norma
AWS A 5.15 : E Ni Fe Cl
EN ISO 1071 : EC NiFe-Cl1
DIN 8573 : E Ni Fe BG 13

Position

Polarity (+)
Mechanic
Re : 390 MPa
Rm : 550 MPa

Ø	Length	Diameter	Code	kg
Ø 2.5	12		083332 21.50 EHT	
Ø 3.2	9		083349 24.50 EHT	
Ø 3.2	156		081956 318.00 EHT	

RECHARGEMENT - Hardfacing - Auftragschweißen - Recargue - Herladen - Enchimento



Normes - Norms - Normen - Norma
EN 14700 : E Fe 2
DIN 8555 : E2-UM-60

Position

Polarity (-)
Mechanic
55/60 HRC
580-610 HB

Ø	Length	Diameter	Code	kg
Ø 3.2	450	141	081529 130.00 EHT	6.6
Ø 4.0	450	93	081512 126.00 EHT	6.8

Ø	Length	Diameter	Code	kg
Ø 2.5	350	46	081543 26.50 EHT	1
Ø 3.2	450	22	081574 23.00 EHT	1
Ø 4.0	450	14	081581 22.50 EHT	1

CARQUOIS ISOTHERMIQUE POUR ÉLECTRODES - Electrode canister - Thermo-Isolierbox für Schweißelektroden

45 cm
Capacité - Capacity
- Kapazität - Capacidad :
7 kg
060258 **21.30** EHT



ÉTUVES ÉLECTRODES - Electrodes oven - Elektrodenofen

DRY 5.150
Capacity :
5 kg - 150°C
060685 **65.00** EHT



DRY 5.200R
Capacity :
5 kg - 50-200°C
060692 **139.00** EHT



DRY 10.350R
Capacity :
10 kg - 50-400°C
060708 **316.00** EHT





GTAW TIG DC



Adjustable Downslope
Automatic Postgas



PATENTS REGISTERED
EUROPEAN TRADEMARK & DESIGN

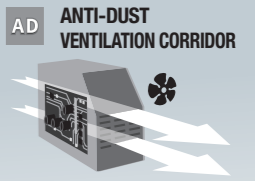
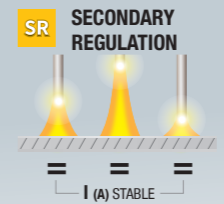
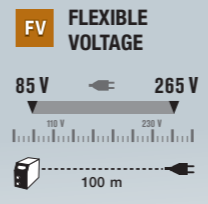
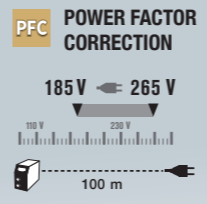

10/25mm²
Ø 9 mm



35/50mm²
Ø 13 mm



35/50mm²
Ø 13 mm



35/50mm²
Ø 13 mm

POWER FACTOR CORRECTION
PFC
EN 61000-3-12
FV
FLEXIBLE VOLTAGE

POWER FACTOR CORRECTION
PFC
EN 61000-3-12
FV
FLEXIBLE VOLTAGE



35/50mm²
Ø 13 mm

OPTION
Cooling unit WCU 0.5kW A
500 W, 1.5 L, 8 kg
liquid not included
039490 675,00 €HT



35/50mm²
Ø 13 mm

OPTION
Cooling unit WCU 1kW B
1000 W, 3 L, 15 kg
liquid not included
032217

TIG 160 DC LIFT

160 A 230V • 1~

P400

L/DB

2m, 16mm² 1.6m, 16mm² SR17DB, 4m
011106 606,00 €HT

PROTIG 161 DC

160 A 230V • 1~

P400 SR AID TIG PULSE

L/DB MMA PULSE

no accessories:
066649 803,00 €HT

2m, 25mm² 2 m, 25mm² SR17DB, 4m
062054 948,00 €HT

PROTIG 200 DC

200 A 230V • 1~

P400 SR AID TIG PULSE

L/DB MMA PULSE

no accessories:
062009 1 201,00 €HT

2m, 25mm² 2m, 25mm² SR26DB, 4m

PROTIG 201 DC FV

200 A 110 → 230V • 1~

P400 PFC FV SR AID TIG PULSE

L/DB/P

no accessories:
065772 1 156,00 €HT

2m, 25mm² 2m, 25mm² SR17DB, 4m
065765 1 325,00 €HT

PROTIG 221 DC FV

220 A 110 → 230V • 1~

P400 PFC FV SR AID TIG PULSE

L/DB/P

MMA PULSE

no accessories:
012431 1 231,00 €HT

TIG 300 DC

300 A 400V • 3~

SR AID TIG PULSE

CONNECT 5 ARC ON L/DB/P

CEL cellulosic MMA PULSE

AD IP 23

no accessories:
012318

OPTIONS

Heavyduty case - Valise de chantier - Gerätekoffer
↳ 21 x 43 x 57 cm
3.9 kg

- ✓ 160 DC-LIFT
- ✓ 161 DC

060432 149,00 €HT

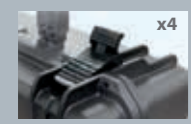

Foot pedal RC-FA1
4 m
045682 338,00 €HT



Hand remote control RC-HA1
8 m
045675



IP67

CE NORM. EN60974-1	50/60 Hz	I ₂ TIG	I ₂ MMA	INTEGRATED TECHNOLOGY										TIG			MMA			Protected & compatible power generator (+/-15%)						
				P400	PFC	FV	SR	AID	TIG PULSE	MMA PULSE	CEL	AD	IP23	EN60974-1 (40°C)			EN60974-1 (40°C)									
														I _A (60%)	X% (I ₂ max)	100%	I _A (60%)	X% (I ₂ max)	U _o		cm	kg				
MADE IN FRANCE	TIG 160 DC Lift	230V 1~	16	20+160	20+160	■	—	—	—	—	—	—	—	—	—	—	95 A	22 %	—	80 A	17 %	72 V	21 x 27 x 14	9	6 kW	7.5 kVA
	PROTIG 161 DC	230V 1~	16	10+160	10+160	■	—	—	■	■	0.1+100 Hz	0.4+20 Hz	—	—	—	—	105 A	20 %	95 A	95 A	15 %	92 V	36 x 28 x 16	7.5	6 kW	7.5 kVA
MADE IN GYS CHINA	PROTIG 200 DC	230V 1~	16	5+200	10+160	■	—	—	■	■	0.1+900 Hz	0.4+20 Hz	—	—	—	—	115 A	20 %	90 A	90 A	20 %	65 V	43 x 33 x 21	10	7 kW	
	PROTIG 201 DC FV	110V 1~ 230V 1~	32 16	10+180 10+200	10+140 10+200	■	■	■	■	■	0.1+2000 Hz	0.4+20 Hz	—	—	—	—	125 A 165 A	25 % 30 %	110 A 140 A	100 A 135 A	25 % 20 %	70 V	41 x 20 x 23	10	6 kW	7.5 kVA
MADE IN FRANCE	PROTIG 221 DC FV	110V 1~ 230V 1~	32 13	5+180 5+220	10+140 10+200	■	■	■	■	■	0.1+2000 Hz	0.4+20 Hz	—	—	—	—	125 A 165 A	40 % 25 %	140 A	120 A 135 A	30 % 25 %	76 V	42 x 35 x 23	14	8.5 kW	
	TIG 300 DC	400V 3~	16	5+300	10+250	—	—	—	■	■	0.1+2000 Hz	0.4+20 Hz	■	■	■	■	255 A	35 %	240 A	220 A	30 %	90 V	52 x 40 x 25	23	10 kW	12.5 kVA

GTAW TIG DC



SOFTWARE UPDATE



TIG

STANDARD DC	LIFT
PULSE	SPOT
FAST PULSE 10 > 20 kHz	TACK

WAVE FORMS

Pulse 16 combinations

- Square
- Trapeze
- Sinus
- Triangle

CONSTANT ENERGY

MMA

STANDARD	PULSE
----------	-------

PRODUCTIVITY

QUICK LOAD MULTIJOB

JOB list

JOB sequence

AUTOMATION

CONNECT 5 A.R.C. ON

SAM

AUTOMATE / ROBOT

OPTION
Cooling unit WCU 1kW 3
1000W, 5.5 L, 15 kg
liquid not included
013537

TITAN 400 DC
400 A 400 V • 3~
SR AID L/DB/P IP 23
no accessories:
013520

OPTIONS

- Foot pedal RC-FA1 4 m 045682 338€ HT
- Hand remote control RC-HA1 8 m 045675
- Remote control RC-HD2 062122
- Filter kit 046580 50€ HT
- USB key 16 Go/GB included 062344 32€ HT
- Skate TITAN (+WCU) 700 x 100 x 350 mm 037717 199€ HT

CE NORM. EN60974-1	MADE IN FRANCE	50 / 60 Hz	A	I ₂ TIG	I ₂ MMA	INTEGRATED TECHNOLOGY										Protected & compatible power generator (+/-15%)					
						SR	TIG PULSE	ETIG	WAVE FORMS	MMA PULSE	CEL	IP23	TIG EN60974-1 (40°C)		MMA EN60974-1 (40°C)		U ₀	cm	kg		
						I (60%)	X% (I2 max)	100%	IA (60%)	X% (I2 max)											
TITAN 400 DC		400V 3~	32	3 → 400	5 → 400		0.1 → 20 000 Hz						400 A	60%	360 A	400 A	60%	82 V	68 × 30 × 54	40	30 kW

HF IGNITION CONTROL UNIT

✓ 2T ✓ 4T
✓ HF 9kV

UNIVERSAL

DC POWER SOURCE → EXATIG → TIG WELDING



EXATIG
no accessories:
013780



FULL CONTROL
SPECIAL EXAGON 400



OPTIONS EXATIG

- Tuyau caoutchouc-Rubber hose, Ø 6.0 X 12 (DIN 73379) x2 045712 11€ HT
- Power cable 10 m 032446 445€ HT
- 4 m 046269 24€ HT
- 8 m 046276 8€ HT
- x 2 for Exatig

EXATIG / EXAGON connection

- Command cable 2.8 m 063907 115€ HT
- 6 m 063914 138€ HT
- 11 m 036925 174€ HT
- Connection kit 036918 61€ HT



CE NORM. EN60974-1	MADE IN FRANCE	I ₂ TIG	U ₁ min	U ₁ max	X% GYS (20°C) for normal use	EN60974-1 (40°C)	I (60%)	X% (I2 max)	100%	cm	kg
EXATIG		40 → 400	10 V	100 V	100% @ 220 A		270 A	25%	220 A	34 × 26 × 16	6.5

POWER SUPPLY FOR ORBITAL TIG DC

CAN OPEN PROTOCOL
REAL TIME TRACKING
✓ HF ✓ LIFT

POWER FACTOR CORRECTION
PFC
EN 61000-3-12
FV
FLEXIBLE VOLTAGE



ORBITIG 200A
220 A 110 → 230 V • 1~
PFC FV SR
no accessories:
012448

CE NORM. EN60974-1	MADE IN FRANCE	50 / 60 Hz	A	A	EN60974-1 (40°C)		mm ²	cm	kg		
					X% (I2 max)	I2 (60%)					
					I (60%)	X% (I2 max)					
ORBITIG 200A		110V 1~ 230V 1~	32	16	5 → 180	40%	125A	110A	35/70	39 × 29 × 16	9

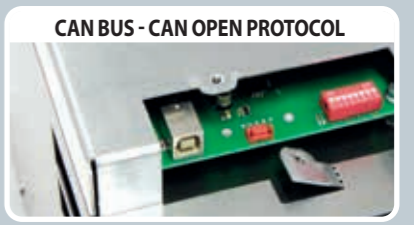



TIG AC/DC

GTAW
TIG
AC/DC



Youtube

VRD inside Voltage Reduction Device

Software & Hardware protection		
	U _o (EN60974-1)	U (Voltmeter)
VRD ON	26 V	29 V
VRD OFF	70 V	57 V
ON → OFF sensibility	< 200 Ω	
OFF → ON delay	< 0.3 s	



ACCESSIBILITY

ERGONOMIC & EASY
Large 5 inch LCD colour screen

8 languages

- French
- English
- German
- Italian
- Spanish
- Portuguese
- Dutch
- Russian

TIG

STD AC/DC	SPOT
PULSE	TACK
LIFT	AC MIX

WAVE FORMS

AC & Pulse
4 combinations

MMA

STANDARD PULSE

MMA AC

AUTOMATION

CONNECT 5 ARC ON

for Automation (5 programs)

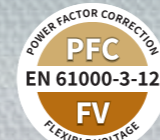

35/50 mm²
Ø 13 mm

35/50 mm²
Ø 13 mm

35/50 mm²
Ø 13 mm

PROTIG 200 AC/DC

200 A	230 V • 1~
P400 SR VRD inside	TIG PULSE
L/DB/P AD	MMA PULSE

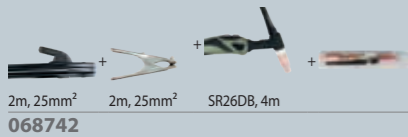

PROTIG 201 AC/DC FV

200 A	110 → 230 V • 1~
P400 PFC FV SR VRD inside	TIG PULSE
L/DB/P AD	MMA PULSE

no accessories:

061828 **1 875,00 €HT**

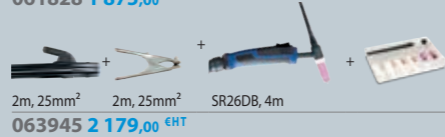

PROTIG 201L AC/DC

200 A	230 V • 1~
P400 PFC SR VRD inside	TIG PULSE
L/DB/P AD	MMA PULSE

no accessories:

062610 **2 494,00 €HT**

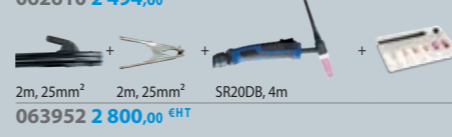

TIG 220 AC/DC FV

220 A	110 → 230 V • 1~
P400 PFC FV SR	TIG PULSE
AID TIG PULSE	WAVE FORMS
CONNECT 5 ARC ON	L/DB/P
MMA PULSE	IP 23

no accessories:
011908



TIG 250 AC/DC

250 A	400 V • 3~	250A	60 %
SR AID TIG PULSE	TIG PULSE	TIG	
CONNECT 5 ARC ON	L/DB/P		
IP 23	FAN LESS		

no accessories:
012004



OPTION Cooling unit WCU 1kW A
1000 W, 3 L, 14 kg
liquid not included
039773 1 063€ HT



CE NORM. EN60974-1	I ₂ TIG A	INTEGRATED TECHNOLOGY														TIG				MMA		Freq. AC	⊕	⚙️	⬆️	⚖️	🔌	🛡️
																EN60974-1 (40°C)				EN60974-1 (40°C)								
		AC	DC	P400	PFC	FV	SR	AID	TIG PULSE	WAVE FORMS	IP23	FAN LESS	AD	I (60%)	X% (I2 max)	100 %	I (60%)	X% (I2 max)	Hz	U _o	mm ²							
MADE IN GYS CHINA	PROTIG 200 AC/DC	230V-1~	13	10+200	10+160	■	—	—	■	■	0.1 → 2000Hz (DC) 0.1 → 10 Hz (AC)	—	—	—	■	AC 90 A	DC 100 A	AC 13%	DC 25%	—	100 A	25%	20 → 200	70 V	Ø 13, 35/50	41 × 36 × 24	15	7.5 kW
MADE IN FRANCE	PROTIG 201 AC/DC FV	110V-1~	20	10+160	10+160	■	■	■	■	■	0.1 → 2000Hz (DC) 0.1 → 10 Hz (AC)	—	—	—	■	AC 105 A	DC 120 A	AC 20%	DC 25%	—	90 A	32%	20 → 200	70 V	Ø 13, 35/50	41 × 36 × 24	15	7.5 kW
	PROTIG 201 L AC/DC	230V-1~	13	10+200	10+160	■	—	—	■	■	0.1 → 2000Hz (DC) 0.1 → 10 Hz (AC)	—	—	—	■	AC 90 A	DC 100 A	AC 13%	DC 25%	—	100 A	25%	20 → 200	70 V	Ø 13, 35/50	43 × 50 × 24	20.5	7.5 kW
	TIG 220 AC/DC FV	110V-1~	32	10+140	5+140	■	■	■	■	■	0.1 → 2500Hz (DC) 0.1 → 2 Hz (AC)	■	■	—	■	AC/DC: 140 A	DC 100 A	AC/DC: 100%	DC 35%	170 A	140 A	75%	20 → 200	75 V	Ø 13, 35/50	62 × 46 × 35	22	8.5 kW
	TIG 250 AC/DC	230V-1~	16	10+220	5+220	■	■	■	■	■	0.1 → 2500Hz (DC) 0.1 → 2 Hz (AC)	■	■	—	■	AC 185 A	DC 175 A	AC 45%	DC 35%	200 A	230 A	40%	20 → 200	85 V	Ø 13, 35/50	48 × 80 × 75	58	10 kW/12.5 kVA



TITANIUM

GTAW TIG AC/DC

CUSTOMISATION

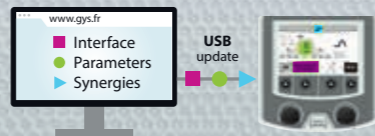

ACCESSIBILITY

- 3 interface levels
- EASY
 - ADVANCED
 - EXPERT
- 10 languages
- French
 - English
 - German
 - Italian
 - Spanish
 - Czech
 - Dutch
 - Russian
 - Chinese
 - Japanese

TIG DC Synergic

TIG AC Pulse

TIG DC Tack



TIG

- STANDARD AC/DC
- PULSE
- FAST PULSE
2.5 > 20 kHz
- HF / LIFT / TOUCH HF
- SPOT / MULTISPOT
- TACK / MULTITACK
- AC MIX

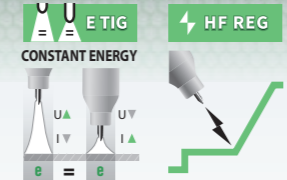
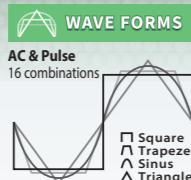

MMA

- STANDARD PULSE
- 15 > 150 HZ
- MMA AC
- WAVE FORMS

MANUAL

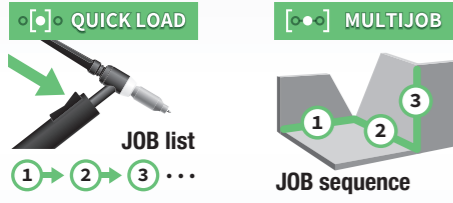

AUTOMATION

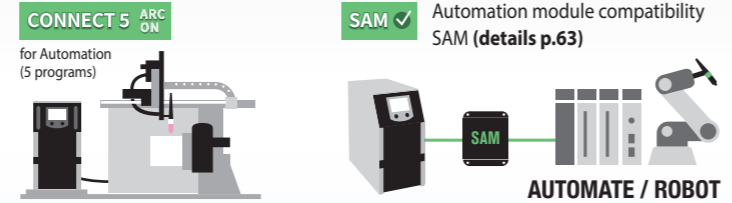

WIZARD ALU

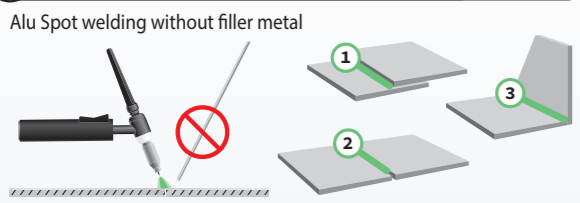

TIG WIZARD

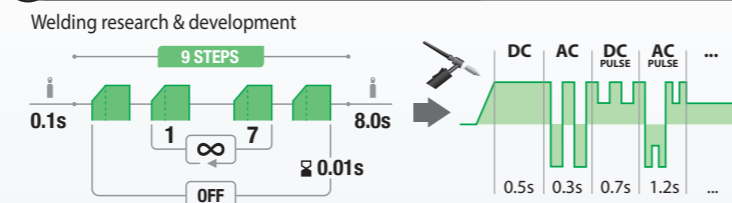

DEGAUSS

Pack

TITANIUM 400 DEGAUSS

067981

TITANIUM 400 AC/DC 013568

RC-DEGAUSS, 8m 066496

DEGAUSS cables kit (2x13)+(1x20) m, Texas 50.21 067929

DEGAUSS USB key 067974

CONNECTIVITY

TRACEABILITY

History data export

QMOS - WPQR

DMOS - WPS

ENERGY CONTROL : 20 kHz, kJ or kJ/cm

PORTABILITY

Share configuration & jobs

SOFTWARE UPDATE

Titanium evolutions

gys.fr



TITANIUM 230 AC/DC

230 A 110-230 V • 1~

230A 60% TIG

PFC FV SR

L/DB/P IP 23

TIG PULSE MMA PULSE

no accessories: 061996



TITANIUM 400 AC/DC

400 A 400 V • 3~

400A 60% TIG

SR L/DB/P IP 23

TIG PULSE MMA PULSE

no accessories: 013568

OPTIONS

for Titanium 230

COMING SOON

Diablo 10m³ New Design 076341

Skate 073593 126.00 € HT

for Titanium 230

COMING SOON

Cooling unit KOOL 1.24 TIG 800 W, 5.5 l, 15 kg liquid not included 070820

for Titanium 400

Cooling unit WCU 1kW C 1000 W, 5.5 l, 15 kg liquid not included 013537

Foot pedal RC-FA1 4 m 045682 338.00 € HT

Hand remote control RC-HA1 8 m 045675

Filter kit 046580 50.00 € HT

USB key 16 Go/GB included 062344 32.00 € HT

EN60974-1	MADE IN FRANCE	50/60 Hz	A	A	SR	INTEGRATED TECHNOLOGY					EN60974-1(40°C) TIG			EN60974-1 (40°C) MMA		Freq. AC	Uo	mm ²	cm	kg	Protected & compatible power generator (+/-15%)		
						TIG PULSE	E TIG	WAVE FORMS	MMA PULSE	CEL	AD	IP23	I (60%)	X% (I2 max)	100%							I (60%)	X% (I2 max)
TITANIUM 230 AC/DC		110-230 V 1~	-	-	-	0.1 → 20 000 Hz (DC) 0.1 → 500 Hz (AC)	■	■	■	■	■	■	-	-	-	-	-	-	-	-	-		
TITANIUM 400 AC/DC		400 V 3~	16	5 → 400 (AC) 3 → 400 (DC)	■	0.1 → 20 000 Hz (DC) 0.1 → 500 Hz (AC)	■	■	■	■	■	■	400 A	60%	360 A	400 A	60%	20 → 300	85	Ø13 70/95	70 × 48 × 30	43	30 kW



220 DC FV					
pack TIG 220 DC FV AL1 012516 1 561 ⁰⁰ eht	SR26 L , 8 m 046184		4 m, 25 mm ² 043794	cooling unit 3l, liquid not included	550 x 1115 x 525 mm
pack TIG 220 DC FV ADB1 012561 1 545 ⁰⁰ eht		SR26 DB , 8 m 046177	4 m, 25 mm ² 043794		
pack TIG 220 DC FV WL1 012523 2 703 ⁰⁰ eht	SR20 L , 8 m 046153		4 m, 25 mm ² 043794	WCU 0.5kW A 500W 039490	Diable 10m³ (max 10 m ³) 039704
pack TIG 220 DC FV WDB1 012578 2 706 ⁰⁰ eht		SR20 DB , 8 m 046146	4 m, 25 mm ² 043794	WCU 0.5kW A 500W 039490	Diable 10m³ (max 10 m ³) 039704

300 DC					
pack TIG 300 DC AL1 012325	SR26 L , 8 m 046184		4 m, 25 mm ² 043794	cooling unit 3l, liquid not included	550 x 1115 x 525 mm
pack TIG 300 DC AL2 012332	SR26 L , 8 m 046184		4 m, 25 mm ² 043794		Diable 10m³ (max 10 m ³) 039704
pack TIG 300 DC ADB1 012349		SR26 DB , 8 m 046177	4 m, 25 mm ² 043794		
pack TIG 300 DC ADB2 012356		SR26 DB , 8 m 046177	4 m, 25 mm ² 043794		Diable 10m³ (max 10 m ³) 039704
pack TIG 300 DC WL 012363	SR20 L , 8 m 046153		4 m, 25 mm ² 043794	WCU 1kW B 1000W 032217	
pack TIG 300 DC WDB1 012370		SR20 DB , 8 m 046146	4 m, 25 mm ² 043794	WCU 1kW B 1000W 032217	Diable 10m³ (max 10 m ³) 039704
pack TIG 300 DC WDB2 012509		SR20 DB , 4 m 038202	4 m, 25 mm ² 043794	WCU 1kW B 1000W 032217	Diable 10m³ (max 10 m ³) 039704

TITAN 400 DC TRI					
pack TITAN 400 DC WL 013766	450W L , 8 m 037359		4 m, 70 mm ² 043831	WCU 1kW C 1000W 013537	T/M 400 A (10 m ³) 037328
pack TITAN 400 DC WDB 013773		450W DB , 8 m 037366	4 m, 70 mm ² 043831	WCU 1kW C 1000W 013537	Trolley TIG 400 (10 m ³) 037328

Cooling liquid (not included)

5L
062511
68⁰⁰ eht

10L
052246
138⁰⁰ eht

Pressure-regulators (not included)
p. 90

201 AC/DC FV					
pack TIG 201 AC/DC FV L 066342 2 715 ⁰⁰ eht	SR26 L , 8 m 046184		4 m, 25 mm ² 043794	cooling unit 3l, liquid not included	550 x 1115 x 525 mm EN ISO 3821 Ø 6.3/12 - 1.5 m 066670
201L AC/DC					
pack TIG 201L AC/DC L 066359 3 363 ⁰⁰ eht	SR20 L , 8 m 046153		4 m, 25 mm ² 043794	cooling unit 3l, liquid not included	666 x 1032 x 484 mm EN ISO 3821 Ø 6.3/12 - 1.5 m 066670

220 AC/DC FV					
pack TIG 220 AC/DC FV AL1 012073	SR26 L , 8 m 046184		4 m, 25 mm ² 043794	cooling unit 3l, liquid not included	912 x 910 x 507 mm 550 x 1115 x 525 mm
pack TIG 220 AC/DC FV AL2 012080	SR26 L , 8 m 046184		4 m, 25 mm ² 043794		10m³-XL/TM2 (max 10 m ³) 039711
pack TIG 220 AC/DC FV AL3 012097	SR26 L , 8 m 046184		4 m, 25 mm ² 043794		Diable 10m³ (max 10 m ³) 039704
pack TIG 220 AC/DC FV ADB1 035751		SR26 DB , 8 m 046177	4 m, 25 mm ² 043794		
pack TIG 220 AC/DC FV ADB2 012103		SR26 DB , 8 m 046177	4 m, 25 mm ² 043794		10m³-XL/TM2 (max 10 m ³) 039711
pack TIG 220 AC/DC FV ADB3 012127		SR26 DB , 8 m 046177	4 m, 25 mm ² 043794		Diable 10m³ (max 10 m ³) 039704
pack TIG 220 AC/DC FV WL1 012134	SR20 L , 8 m 046153		4 m, 25 mm ² 043794	WCU 1kW A 1000W 039773	
pack TIG 220 AC/DC FV WL2 012141	SR20 L , 8 m 046153		4 m, 25 mm ² 043794	WCU 1kW A 1000W 039773	10m³-XL/TM2 (max 10 m ³) 039711
pack TIG 220 AC/DC FV WL3 012271	SR20 L , 8 m 046153		4 m, 25 mm ² 043794	WCU 1kW A 1000W 039773	Diable 10m³ (max 10 m ³) 039704
pack TIG 220 AC/DC FV WDB1 035768		SR20 DB , 8 m 046146	4 m, 25 mm ² 043794	WCU 1kW A 1000W 039773	
pack TIG 220 AC/DC FV WDB2 012288		SR20 DB , 8 m 046146	4 m, 25 mm ² 043794	WCU 1kW A 1000W 039773	10m³-XL/TM2 (max 10 m ³) 039711
pack TIG 220 AC/DC FV WDB3 012295		SR20 DB , 8 m 046146	4 m, 25 mm ² 043794	WCU 1kW A 1000W 039773	Diable 10m³ (max 10 m ³) 039704

250 AC/DC					
pack TIG 250 AC/DC L 035430	SR18 L , 8 m 045378				Chariots/Trolley max 10 m ³ 040960 4 m, 25 mm ² 043794
pack TIG 250 AC/DC DB 012301		SR18 DB , 8 m 046092			Chariots/Trolley max 10 m ³ 040960 4 m, 25 mm ² 043794

TITANIUM 400 AC/DC					
pack TIG 400 AC/DC WL 014763	450W L , 8 m 037359		4 m, 70 mm ² 043831	WCU 1kW C 1000W 013537	Trolley TIG 400 (10 m ³) 037328
pack TIG 400 AC/DC WDB 062047		450W DB , 8 m 037366	4 m, 70 mm ² 043831	WCU 1kW C 1000W 013537	Trolley TIG 400 (10 m ³) 037328

MÉTAUX D'APPORT TIG - TIG filler rods - WIG-Schweißstäbe

	Ø (mm)	↔ (m)	⊥	Δ (kg)	
Acier - Steel - Stahl (SG2) AWS A 5.18 : ER70S-6 EN ISO 636A : W46 4 W3511	1.2	1	587	5	069411 50,00 € HT
	1.6	0,33	60	0,33	087224 7,00 € HT
	1	319	5	087019 52,00 € HT	
	2.0	0,33	40	0,33	087231 7,00 € HT
	1	204	5	087217 51,00 € HT	
	2.4	0,33	27	0,33	069572 5,00 € HT
Inox - Stainless - Edelstahl (308L) AWS A 5.9 : ER 308L EN ISO 14343A : W199L	1.2	1	110	1	069497 25,00 € HT
	1	560	5	087156 108,00 € HT	
	0,33	60	0,33	087248 11,00 € HT	
	1.6	1	60	1	069428 25,00 € HT
	1	315	5	087156 108,00 € HT	
	0,33	40	0,33	087255 11,00 € HT	
Inox - Stainless - Edelstahl (316L) AWS A 5.9 : ER 316L EN ISO 14343A : W19 12 3L	1.2	1	110	1	069442 36,00 € HT
	1	560	5	069480 158,00 € HT	
	0,33	60	0,33	087262 14,00 € HT	
	1.6	1	60	1	069459 36,00 € HT
	1	315	5	087125 158,00 € HT	
	0,33	40	0,33	087279 14,00 € HT	
Alu - Aluminium - Aluminio (AIMg5) AWS A 5.10 : ER 5356 EN ISO 18273 : 5 Al 5356	1.2	1	110	1	069442 36,00 € HT
	1	560	5	069480 158,00 € HT	
	0,33	60	0,33	087286 13,00 € HT	
	2.0	1	590	5	087187 131,00 € HT
	0,33	27	0,33	069565 10,00 € HT	
	2.4	1	410	5	087194 129,00 € HT
Cuivre - Copper - Kupfer (ErCu)	2.0	0,33	36	0,33	069558 23,00 € HT
	2.0	0,33	5	-	047280 5,00 € HT
Titane - Titanium - Titan T40 ERTI-2	1.6	0,33	83	0,25	069541 85,00 € HT

STYLO MÉTAUX D'APPORT TIG - TIG filler rods feeder pen - WIG Pen zur Führung des WIG-Stabes



for Ø 1.0 x 3.2 mm
130 x 15 mm
065857 50,00 € HT

COMMANDES DÉPORTÉES - Remote control - Fernregler



SUPPORT TORCHE TIG MAGNÉTIQUE - TIG torch stand with magnetic base - WIG-Brennerhalter mit Magnetfuß



Tuyau caoutchouc - Gas hose - Ø 6.3 X 13 (EN ISO 3821)



1.5 m 066670 11,00 € HT
4 m 046269 24,00 € HT
x m 046276 8,00 € HT

MIG / MAG / TIG Débitmètre bout de torche Torch Gas Flow Meter Durchflussmesserrohr



053939 30,00 € HT

ÉLECTRODES TUNGSTÈNE - Tungsten electrodes - Wolfram Elektroden

AC & DC						AC	
WL15 LANTHANE 1.5% Gold	WL20 LANTHANE 2% Blue	WC CERIUM 2% Grey	E3® Lila	WR2 RARE EARTHS 2% Turquoise	LYMOX LUX® W + RARE EARTHS 4% Fuchsia/Grey	WP PUR Green	
Quality ★★★ Economic	Quality ★★★ Economic	Quality ★★★ Economic	Quality ★★ Economic	Quality ★ Economic	Quality ★★★ Economic	Quality ★★ Economic	
Fe/Cr/Ni ■■■ Al ■■■■ ~ ■■■■	Fe/Cr/Ni ■■■ Al ■■ ~ ■■■■	Fe/Cr/Ni ■■■■ Al ■■ ~ ■■■■	Fe/Cr/Ni ■■■■ Al ■■ ~ ■■■■	Fe/Cr/Ni ■■ Al ■ ~ ■■■■	Fe/Cr/Ni ■■■■ Al ■■■■ ~ ■■■■	Fe/Cr/Ni ■■■ Al ■■■ ~ ■■■■	
Ø 1.6 x10 045330 22,00 € HT Ø 2.0 x10 045347 34,00 € HT Ø 2.4 x10 045354 45,00 € HT Ø 3.2 x10 045361 79,00 € HT	Ø 1.6 x10 037137 27,00 € HT Ø 2.0 x10 037120 40,00 € HT Ø 2.4 x10 037144 54,00 € HT Ø 3.0 x10 037151 86,00 € HT Ø 3.2 x10 037168 91,00 € HT Ø 4.0 x10 037175 155,00 € HT	Ø 1.6 x10 063174 26,00 € HT Ø 2.4 x10 063181 53,00 € HT Ø 3.2 x10 063198 89,00 € HT	Ø 1.6 x10 046733 25,00 € HT Ø 2.0 x10 046764 37,00 € HT Ø 2.4 x10 046771 49,00 € HT Ø 3.2 x10 046788 84,00 € HT Ø 4.0 x10 046795 142,00 € HT Ø 4.8 x10 063167 201,00 € HT	Ø 1.6 x10 044586 23,00 € HT Ø 2.0 x10 044593 35,00 € HT Ø 2.4 x10 044609 48,00 € HT Ø 3.2 x10 044616 81,00 € HT	Ø 1.6 x10 072428 Ø 2.0 x10 072435 Ø 2.4 x10 072442 Ø 3.2 x10 072459	Ø 1.6 x10 044555 22,00 € HT Ø 2.0 x10 046719 33,00 € HT Ø 2.4 x10 044579 44,00 € HT Ø 3.2 x10 046726 75,00 € HT	

WAG 40 / AFFUTEUR ÉLECTRODES TUNGSTÈNE - Tungsten electrode grinder - Wolframelektroden-Anschleifgerät

with accessories: 045415 1 163,00 € HT

INCLUDED
- Adaptateurs électrode - Electrode adaptor - Spannzange Ø 1.6 - Ø 2.4 - Ø 3.2 mm
- Filtre poussière - Dust filter - Filterkassette 045422 45,00 € HT
- Disque diamanté Ø 40 / Diamond blade cutting disc Ø 40 / Diamantschleifscheibe Ø 40 045439 119,00 € HT

ADAPTEURS ÉLECTRODE - Electrode adaptors - Spannzange
Ø 1 045446 32,00 € HT
Ø 2 045453 32,00 € HT
Ø 4 045460 32,00 € HT

1-230V

INTEGRATED AND EXCHANGEABLE FILTER - Integrierte Abspaugung mit auswechselbarer Filterkassette

Réglage angulaire continu: 15 > 180° - Continuous angular adjustment: 15 > 180° - Stufenlose Einstellung des Anschleifwinkels zwischen 15 > 180°

Ajustement précis du «Stick out» (0.3mm) - Precise adjustment of the «Stick out» (0.3mm) - Tiefenlehre zum Einstellen der Elektrodenlänge (0.3mm)

BEST FROM GERMANY

CONNEXIONS TORCHE - TORCH CONNECTIONS
DIN (5pts) x1 045729 11,00 € HT
Amphenol (7 pts, male) x1 046238 13,00 € HT
Amphenol (7 pts, female) x1 064379 57,00 € HT

ADAPTEUR/ADAPTOR FEMELLE/FEMALE > MÂLE/MALE
DIN 5 pts > Amphenol 7 pts (x1) 038486 111,00 € HT
Amphenol 7 pts > DIN 5 pts (x1) 038493 145,00 € HT

GAZ - GAS Ø 5 mm x2 045705 10,00 € HT

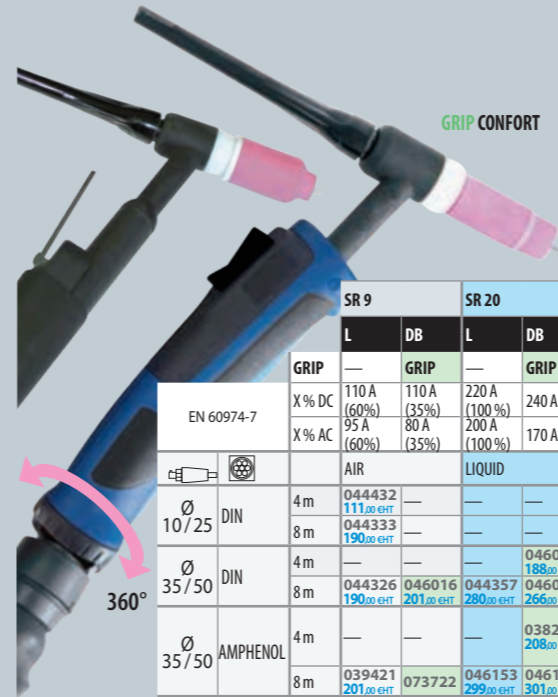

⊕ = original equipment

	Ø 10 / 25	DIN	SR 9	SR 17	SR 26	SR 20	SR 18	260 W	450 W
TIG 160 DC	Ø 35 / 50	AMPHENOL	L DB	DB	L DB				
PROTIG 161 DC	Ø 35 / 50	DIN	L DB	DB	L DB				
TIG 200 DC FV	Ø 35 / 50	AMPHENOL	L DB	DB	L DB				
PROTIG 201 DC FV	Ø 35 / 50	AMPHENOL	L DB	DB	L DB				
TIG 220 DC FV	Ø 35 / 50	AMPHENOL	L DB	DB	L DB				
TIG 300 DC	Ø 35 / 50	AMPHENOL	L DB	DB	L DB				
TITAN 400 DC	Ø 35 / 50	AMPHENOL	L DB	DB	L DB				
PROTIG 201 AC/DC FV	Ø 35 / 50	AMPHENOL	L DB	DB	L DB				
PROTIG 201 AC/DC	Ø 35 / 50	AMPHENOL	L DB	DB	L DB				
TIG 220 AC/DC FV	Ø 35 / 50	AMPHENOL	L DB	DB	L DB				
TIG 250 AC/DC	Ø 35 / 50	AMPHENOL	L DB	DB	L DB				
TITANIUM 400 AC/DC	Ø 35 / 50	AMPHENOL	L DB	DB	L DB				
EXATIG	Ø 35 / 50	AMPHENOL	L DB	DB	L DB				

	SR 9	SR 20	SR 17	SR 18	SR 26	260 W	450 W
EN 60974-7	X % DC 110 A (60%) 95 A (60%)	X % AC 110 A (35%) 80 A (35%)	220 A (100%) 200 A (100%)	240 A (100%) 170 A (100%)	140 A (60%) 125 A (60%)	140 A (35%) 100 A (35%)	320 A (100%) 240 A (100%)
Ø 10/25 DIN	4 m 044432 111,00 € HT 8 m 044333 190,00 € HT	—	—	—	044425 106,00 € HT	046009 128,00 € HT	—
Ø 35/50 DIN	4 m — 8 m 044326 190,00 € HT	046016 201,00 € HT	044357 280,00 € HT	046023 266,00 € HT 046139 451,00 € HT	044401 108,00 € HT 044340 201,00 € HT	061583 221,00 € HT 061590 293,00 € HT	046030 129,00 € HT 046047 203,00 € HT
Ø 35/50 AMPHENOL	4 m — 8 m 039421 201,00 € HT	—	038202 208,00 € HT 046153 299,00 € HT	—	—	073739 143,00 € HT 073746 206,00 € HT	039271 143,00 € HT 072213 129,00 € HT 069404 206,00 € HT 046108 183,00 € HT
EURO - connector (MIG)	4 m — 8 m —	—	—	—	—	—	—

Included with torches

	SR 9	SR 20	SR 17 - SR 18 - SR 26	260 W
V	DC 044654 13,00 € HT Back cap (short+long) Tungsten electrode Ø 1.6 & Ø 2.4 + collets Gas nozzle N4	AC / DC 044685 18,00 € HT Back cap (short+long) Tungsten electrode Ø 1.6 & Ø 2.4 + collets Gas nozzle N4 - N6	AC / DC 044678 19,00 € HT Back cap (short+long) Tungsten electrode Ø 1.6 & Ø 2.4 + collets Gas nozzle N5 - N7	AC / DC 039414 79,00 € HT Back cap (short+long) Tungsten electrode Ø 1.6 & Ø 2.4 + collets Gas nozzle N2 - N3

	SR 9 - SR 20	SR 17 - SR 18 - SR 26	260 W	450 W	
L	N 2 - Ø 8.0 N 3 - Ø 10 N 4 - Ø 6.5 N 5 - Ø 8.0 N 6 - Ø 9.5 N 7 - Ø 11 N 8 - Ø 12.5 Ø 13 Ø 15 N 10 - Ø 16 N 12 - Ø 19	(x3) 044876 3,00 € HT (x3) 038356 3,00 € HT (x3) 044883 3,00 € HT (x3) 038363 3,00 € HT (x3) 045170 3,00 € HT	(x3) 038394 5,00 € HT (x3) 045026 5,00 € HT (x3) 038400 5,00 € HT (x3) 045033 5,00 € HT (x3) 045286 5,00 € HT	(x5) 039438 17,00 € HT (x5) 039391 17,00 € HT	(x5) 037434 17,00 € HT (x5) 037441 17,00 € HT
DB	Ø 1.6 Ø 2.0 Ø 2.4 Ø 3.2 Ø 4	(x3) 044838 10,00 € HT (x3) 045149 10,00 € HT (x3) 044845 10,00 € HT (x3) 045248 10,00 € HT	(x3) 044968 12,00 € HT (x3) 044975 12,00 € HT (x3) 044975 12,00 € HT (x3) 045118 12,00 € HT (x3) 047648 12,00 € HT	—	—
P	Ø 1.6 Ø 2.0 Ø 2.4 Ø 4 Ø 4.8 Longue - Long Courte - Short	(x3) 044852 4,00 € HT (x3) 045132 4,00 € HT (x3) 044869 4,00 € HT (x3) 045255 4,00 € HT	(x3) 044982 5,00 € HT (x3) 044999 5,00 € HT (x3) 045019 5,00 € HT (x3) 045125 5,00 € HT (x3) 047655 5,00 € HT	(x3) 039360 37,00 € HT (x3) 039377 37,00 € HT (x3) 039384 37,00 € HT	(x3) 037397 43,00 € HT (x3) 037403 43,00 € HT (x3) 037410 43,00 € HT (x3) 063396 43,00 € HT
	Ø 1.6 Ø 2.0 Ø 2.4 Ø 3.2	(x1) 044821 4,00 € HT (x1) 044814 3,00 € HT	(x1) 044951 4,00 € HT (x1) 044944 2,00 € HT	(x1) 044746 10,00 € HT (x1) 039407 12,00 € HT	(x1) 037380 21,00 € HT (x1) 037373 12,00 € HT

	SR 9 - SR 20	SR 17 - SR 18 - SR 26	260 W	450 W
L	N 4 - Ø 6.5 N 5 - Ø 8.0 N 6 - Ø 9.5 N 7 - Ø 11	(x3) 044920 4,00 € HT (x3) 045071 5,00 € HT (x3) 044937 4,00 € HT (x3) 045262 4,00 € HT	(x3) 045088 5,00 € HT	—
DB	Ø 1.6 Ø 2.0 Ø 2.4 Ø 3.2	(x2) 044906 13,00 € HT (x2) 045156 13,00 € HT (x2) 044913 13,00 € HT (x2) 045279 13,00 € HT	(x2) 045057 18,00 € HT (x2) 045064 18,00 € HT (x2) 045064 18,00 € HT	—
P	—	(x1) 045095 5,00 € HT	—	—
	—	(x1) 045040 3,00 € HT	—	—

PRO

	SR 9 - SR 20	SR 17 - SR 18 - SR 26	260 W	450 W
L	N 4 - Ø 6.5 N 5 - Ø 8.0 N 6 - Ø 9.5 N 7 - Ø 11	(x3) 044920 4,00 € HT (x3) 045071 5,00 € HT (x3) 044937 4,00 € HT (x3) 045262 4,00 € HT	(x3) 045088 5,00 € HT	—
DB	Ø 1.6 Ø 2.0 Ø 2.4 Ø 3.2	(x2) 044906 13,00 € HT (x2) 045156 13,00 € HT (x2) 044913 13,00 € HT (x2) 045279 13,00 € HT	(x2) 045057 18,00 € HT (x2) 045064 18,00 € HT (x2) 045064 18,00 € HT	—
P	—	(x1) 045095 5,00 € HT	—	—
	—	(x1) 045040 3,00 € HT	—	—



GMAW/FCAW MIG/MAG TRADITIONAL

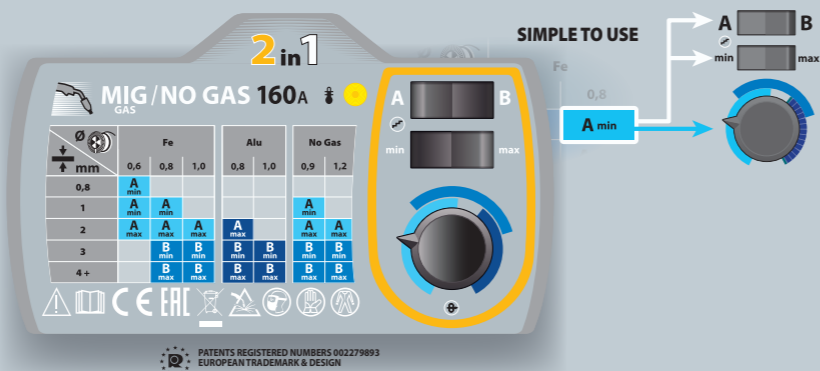

230V • 1~

400V • 3~

SMARTMIG 110
110A ⚡ ⌀ 100
NO GAS



SMARTMIG 142
140A ⚡ ⌀ 100/200
GAS NO GAS



SMARTMIG 152
140A ⚡ ⌀ 100/200
GAS NO GAS



SMARTMIG 162
160A ⚡ ⌀ 100/200
GAS NO GAS
160A on 13A fuse



SMARTMIG 182
180A ⚡ ⌀ 200/300
GAS NO GAS

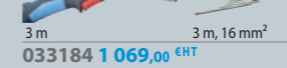

SMARTMIG 183
200A ⚡ ⌀ 200/300
GAS NO GAS



SMARTMIG
MIG/MAG • TRADITIONAL

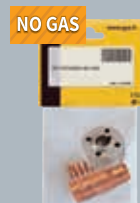

Kit soudage NO GAZ
- No Gas Welding Kit
- Schweißset Fülldraht
Ø 0.9 1.0 / 1.2
041240 **23,00 € HT**

NO GAS Fil fourré / Flux cored wire / Fülldrahtelektrode
INFO

A Inverser les polarités / Reverse polarities / Polarität wechseln
Changer le tube contact / Change the contact tip / Kontaktrohr austauschen

B NO GAS Ø mm Ø mm
0.9 1.0
1.2 1.2

C Changer le galet / Change the roller / DV-Rolle austauschen
SPECIAL NO GAS

D Supprimer la buse / Remove the nozzle / Gasdüse abziehen
OU / OR / ODER
Utiliser une buse spéciale NO GAS (isolée) / Use a special nozzle
NO GAS (isolated) / Spezielle Gasdüse für "NO GAS" (isoliert) verwenden
150 A
Ref. 041868

EN60974-1 (40°C)	Uo (V)	Electronic Control	Ø mm			GAS	NO GAS	TYPE	cm	kg	kW									
			100 mm 1 kg	200 mm 5 kg	300 mm 15 kg							Ø mm								
50/60 Hz	A	+	min+max	Reg	IA (60%)	X% (I2 max)	EN60974-1 (40°C)	Uo (V)	Electronic Control	100 mm 1 kg	200 mm 5 kg	300 mm 15 kg	GAS	NO GAS	TYPE	cm	kg	kW		
SMARTMIG 110	230V 1~	13	—	40+110	2	—	85A @ 6%	25.5+30	☺	■	—	—	—	0.6+0.9	0.9	D-044081	0.9	40x39x19	13.5	3 kW
SMARTMIG 142	230V 1~	13	—	40+140	4	60	90A @ 20%	28+39	☺	■	■	—	0.6+0.8	0.6+0.9	0.6/0.8	A-042339	0.8	50x44x25	22.5	3.5 kW
SMARTMIG 152	230V 1~	13	■	40+140	4	60	90A @ 20%	28+39	☺	■	■	—	0.6+0.8	0.6+0.9	0.6/0.8	A-042339	0.8	48x45x25,5	23	3.5 kW
SMARTMIG 162	230V 1~	16	■	30+160	4	70	115A @ 20%	25.5+40	☺	■	■	—	0.6+1.0	0.9+1.2	0.6/0.8	A-042339	0.8	55,5x46x25,5	28	5 kW
SMARTMIG 182	230V 1~	16	■	35+180	4	80	140A @ 15%	28+45	☺	—	■	■	0.6+1.0	0.9+1.2	0.6/0.8	A-042339	0.8	79x77x47	47	6 kW
SMARTMIG 183	400V 3~	10	■	15+200	7	110	150A @ 25%	16+28.5	☺	—	■	■	0.6+1.0	0.9+1.2	0.6/0.8	A-042339	0.8	79x77x47	53	6.5 kW



PROMIG

EN 1090

ADJUSTABLE WIRE CREEP SPEED

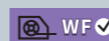

WIRE FEEDER COMPATIBILITY



TF-4RN
AIR
061699
709,00 €HT

TF-4W
LIQUID
061705
738,00 €HT



ACCESSORIES BOX



39

PROMIG

MIG/MAG • TRADITIONAL

GMAW/FCAW MIG/MAG TRADITIONAL • SYNERGIC



35/50 mm²
Ø 13 mm

Liquid cooling
5.5l
liquid not included

35/50 mm²
Ø 13 mm

35/50 mm²
Ø 13 mm

35/50 mm²
Ø 13 mm

Liquid cooling
7l
liquid not included

35/50 mm²
Ø 13 mm

35/50 mm²
Ø 13 mm

COMPACT

GENERATOR

PROMIG 400-4S

400 V • 3~

350 A

Ø 200/300



no accessories:
035898 2 685,00 €HT

PROMIG 400-4S DV WS

230 / 400 V • 3~

350 A

Ø 200/300



no accessories:
061675 3 719,00 €HT

PROMIG 400-4S DUO.DV

230 / 400 V • 3~

350 A

Ø 200/300



no accessories:
035911 2 815,00 €HT

PROMIG 400 G.DV

230 / 400 V • 3~

350 A



no accessories:
035904 2 549,00 €HT

PROMIG 400 G.DV WS

230 / 400 V • 3~

350 A



no accessories:
061682 3 374,00 €HT

Câble d'inversion de polarité
- Polarity reversal cable
- Umpolungskabel



1.3 m 95 mm² 033689 106,00 €HT
5 m 95 mm² 032439 254,00 €HT
10 m 95 mm² 032446 445,00 €HT

Faisceaux de liaison - Connection cable - Zwischenschlauchpakete



AIR COOLED
5 m 50 mm² 034822 396,00 €HT
5 m 70 mm² 034839 440,00 €HT
10 m 50 mm² 034853 640,00 €HT
10 m 70 mm² 034860 689,00 €HT
10 m 95 mm² 045941 830,00 €HT
LIQUID-COOLED
1.6 m 70 mm² 033696 361,00 €HT
5 m 70 mm² 033641 518,00 €HT
10 m 70 mm² 033658 819,00 €HT
10 m 95 mm² 034877 953,00 €HT
15 m 95 mm² 034884 1 428,00 €HT
20 m 95 mm² 034891 2 074,00 €HT

Support câbles
037700 25,00 €HT



EN60974-1

MADE IN FRANCE

Model	Voltage	Current (A)		Wire diameter (mm)	Reg	EN60974-1 (40°C)	U ₀ (V)	Electronic Control	Wire speed (m/min)	Wire diameter (mm)		Gas		Cooling system	Weight (cm/kg)	Power (kW)		
		Norm	Intensive							200 mm	300 mm	GAS	NO GAS					
PROMIG 400-4S	400 V 3~	16	20	40 → 350	14	270	350 A @ 35%	220 A	17-42	20	20	0.6+1.6	—	1.0/1.2	B-046849	112	20 kW	
PROMIG 400-4S DV WS	230 & 400 V 3~	230V: 25 400V: 16	230V: 40 400V: 25	40 → 350	14	270	350 A @ 35%	220 A	17-42	20	20	0.6+1.6	—	1.0/1.2	B-046849	130	20 kW	
PROMIG 400-4S DUO.DV	230 & 400 V 3~	230V: 25 400V: 16	230V: 40 400V: 25	40 → 350	14	270	350 A @ 35%	220 A	17-42	20	20	0.6+1.6	0.9+1.6	1.0/1.2	B-046849	113	20 kW	
PROMIG 400 G.DV	230 & 400 V 3~	230V: 25 400V: 16	230V: 40 400V: 25	40 → 350	14	270	350 A @ 35%	220 A	17-42	—	—	—	OPTION	—	—	—	109	20 kW
PROMIG 400 G.DV WS	230 & 400 V 3~	230V: 25 400V: 16	230V: 40 400V: 25	40 → 350	14	270	350 A @ 35%	220 A	17-42	—	—	—	OPTION	—	—	—	113	20 kW
TF-4RN	—	—	—	—	—	—	—	—	—	20	20	0.6+1.6	0.9+1.6	1.0/1.2	B-046849	113	20 kW	
TF-4W	—	—	—	—	—	—	—	—	—	20	20	0.6+1.6	0.9+1.6	1.0/1.2	B-046849	19	20 kW	



Protected & compatible power generator (+/-15%)

OPTIONS

38

X%

MAGYS 400 **350 A - 50%**
MAGYS 500 **450 A - 50%**
FULL SYNERGIC MIG OVER 1 000 PARAMETERS

EN 1090



ADJUSTABLE ELECTRONIC CONTROL • CREEP SPEED • BURN BACK • POST GAS



DYNAMIC ARC CONTROL TECHNOLOGY



MATERIAL THICKNESS TEST



4 DRIVE ROLLERS Ø 37 mm
MOTOR 70W
HIGH QUALITY FOR HIGH PRECISION
Rollers Type C
MAGYS 400-4, WS-4R, WS-4L



HIGH STABILITY



EASY CLEANING



SHOCK RESISTANT



MAGYS

GMAW/FCAW
MIG/MAG
TRADITIONAL • SYNERGIC



Youtube



Max 10 m³ (50 L)

70/95 mm²
Ø 13 mm



COMPACT

MAGYS 400-4

350 A

Ø 200/300



AIR

no accessories :
032170

WF WIRE FEEDER COMPATIBILITY



Ø 200/300

WS-4R
AIR
034723

WS-4L
LIQUID
033573

OPTIONS WS-4R/4L



Skate
040977 170€ HT



Wirefeeder support
details p.59
036277 211€ HT



SMALL SIZE
Ø 200
WS-4L
AIR
LIQUID
032835



Max 10 m³ (50 L)

70/95 mm²
Ø 13 mm



GENERATOR

MAGYS 400 GR

350 A

AIR WF

no accessories :
032187

MAGYS 500 GR

450 A

AIR WF GOUGING

no accessories :
032194

MAGYS 500 WS

450 A

LIQUID WF GOUGING

no accessories :
032200

MAGYS
MIG/MAG • TRADITIONAL

41



OPTIONS

Câble d'inversion de polarité
- Polarity reversal cable
- Umpolungskabel



1.3 m 95 mm² 033689 106€ HT
5 m 95 mm² 032439 254€ HT
10 m 95 mm² 032446 445€ HT

Faisceaux de liaison - Connection cable
- Zwischenschlauchpakete



AIR COOLED
5 m 50 mm² 034822 396€ HT
5 m 70 mm² 034839 440€ HT
10 m 50 mm² 034853 640€ HT
10 m 70 mm² 034860 689€ HT
10 m 95 mm² 045941 830€ HT
LIQUID COOLED
1.6 m 70 mm² 033696 361€ HT
5 m 70 mm² 033641 518€ HT
5 m 70 mm² 033658 819€ HT
10 m 70 mm² 034877 953€ HT
15 m 95 mm² 034884 1 428€ HT
20 m 95 mm² 034891 2 074€ HT

GOUGING Gougeage - Gouging - Fugenhobeln



Ø 8 mm max
041516 329€ HT



Câble pour pince de gougeage
- Cable for gouging torch
- Anschlusskabel für Fugenhobel-Brenner

70 mm² - 5 m
040670 186€ HT

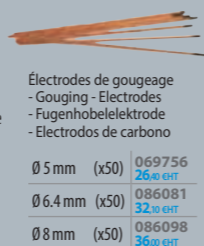

Électrodes de gougeage
- Gouging - Electrodes
- Fugenhobelelektrode
- Electrodo de carbono
Ø 5 mm (x50) 069756 26€ HT
Ø 6.4 mm (x50) 086081 32€ HT
Ø 8 mm (x50) 086098 36€ HT

Screen protection included with Magys



Cable support (x4)
046535 80€ HT

Model	Voltage	Frequency	Phase	Current	Voltage	Current	Efficiency	Power	Voltage	Control	Flow	Weight	Dimensions	Gas	NO GAS	Wire	Type	Cooling	System	Height	Weight	Power	Generator
MAGYS 400-4	400V	3~	20	25	40+350	20	320	350 A @ 50%	260 A	17-43	Ø 20	24	5 kg	15 kg	0.6+1.6	0.9+1.6	1.0/1.2 mm	C	Air	46 x 93 x 110	134	20 kW	Protected & compatible power generator (+/-15%)
MAGYS 400 GR	400V	3~	20	25	40+350	20	320	350 A @ 50%	260 A	17-43	Ø 20	24	5 kg	15 kg	0.6+1.6	0.9+1.6	1.0/1.2 mm	C	Air	46 x 93 x 110	134	20 kW	Protected & compatible power generator (+/-15%)
MAGYS 500 GR	400V	3~	25	32	45+450	30	410	450 A @ 50%	320 A	18-51	Ø 20	24	5 kg	15 kg	0.6+1.6	0.9+2.4	1.0/1.2 mm	C	Air	48 x 93 x 110	152	30 kW	Protected & compatible power generator (+/-15%)
MAGYS 500 WS	400V	3~	25	32	45+450	30	410	450 A @ 50%	320 A	18-51	Ø 20	24	5 kg	15 kg	0.6+1.6	0.9+2.4	1.0/1.2 mm	C	Air	48 x 93 x 110	152	30 kW	Protected & compatible power generator (+/-15%)
WS-4R	400V	3~	20	25	40+350	20	320	350 A @ 50%	260 A	17-43	Ø 20	24	5 kg	15 kg	0.6+1.6	0.9+2.4	1.0/1.2 mm	C	Air	68 x 56 x 35.5	22	—	Protected & compatible power generator (+/-15%)
WS-4L	400V	3~	20	25	40+350	20	320	350 A @ 50%	260 A	17-43	Ø 20	24	5 kg	15 kg	0.6+1.6	0.9+2.4	1.0/1.2 mm	C	Liquid	68 x 56 x 35.5	22	—	Protected & compatible power generator (+/-15%)
WS-4L	400V	3~	20	25	40+350	20	320	350 A @ 50%	260 A	17-43	Ø 20	24	5 kg	15 kg	0.6+1.6	0.9+1.6	0.8/1.0 mm	B	Air + Liquid	32 x 49 x 23	12	—	Protected & compatible power generator (+/-15%)

40

PROMIG 400-4S

			 TYPE B			 Fe/CrNi	 Alu
		pack PROMIG 400-4S 1 035928 3 003,00 €HT		Ø1/1.2 (original equipment)	4m, 50 mm ² 047853		350 A, 4 m, air 040946
			Ø1/1.2 (original equipment)	Alu, Ø1/1.2 (x2) 040915	4m, 50 mm ² 047853		350 A, 3 m, air 040731

PROMIG 400-4S DV WS

	pack PROMIG 400-4S DV WS 1 062740 4 158,00 €HT		Ø1/1.2 (original equipment)	4m, 50 mm ² 047853		500 A, 4 m, liquid 041004	
			Ø1/1.2 (original equipment)	Alu, Ø1/1.2 (x2) 040915	4m, 50 mm ² 047853		500 A, 3 m, liquid 046160

PROMIG 400-G.DV

	pack PROMIG 400-G.DV 1 035942 4 265,00 €HT	TF-4RN 061699	Ø1/1.2 (original equipment)	4m, 50 mm ² 047853	10 m, air, ø 70 mm ² 034860	350 A, 4 m, air 040946	
	pack PROMIG 400-G.DV 3 036109 4 016,00 €HT	TF-4RN 061699	Ø1/1.2 (original equipment)	4m, 50 mm ² 047853	5 m, air, ø 70 mm ² 034839	350 A, 4 m, air 040946	
	pack PROMIG 400-G.DV 2 035959 4 276,00 €HT	TF-4RN 061699	Ø1/1.2 (original equipment)	Alu, Ø1/1.2 (x2) 040915	4m, 50 mm ² 047853	10 m, air, ø 70 mm ² 034860	350 A, 3 m, air 040731
	pack PROMIG 400 G.DV 4 036116 4 027,00 €HT	TF-4RN 061699	Ø1/1.2 (original equipment)	Alu, Ø1/1.2 (x2) 040915	4m, 50 mm ² 047853	5 m, air, ø 70 mm ² 034839	350 A, 3 m, air 040731







PROMIG 400-4S DUO DV

	pack PROMIG 400-4S DUO DV 1 035966 3 133,00 €HT		Ø1/1.2 (original equipment)	4m, 50 mm ² 047853		350 A, 4 m, air 040946		
	pack PROMIG 400-4S DUO DV 2 035973 3 145,00 €HT		Ø1/1.2 (original equipment)	Alu, Ø1/1.2 (x2) 040915	4m, 50 mm ² 047853		350 A, 3 m, air 040731	
	pack PROMIG 400-4S DUO DV 3 035980 4 757,00 €HT	TF-4RN 061699	Ø1/1.2 (original equipment)	Alu, Ø1/1.2 (x2) 040915	4m, 50 mm ² 047853	10 m, air, ø 70 mm ² 034860	350 A, 4 m, air 040946	350 A, 3 m, air 040731
	pack PROMIG 400-4S DUO DV 4 036123 4 508,00 €HT	TF-4RN 061699	Ø1/1.2 (original equipment)	Alu, Ø1/1.2 (x2) 040915	4m, 50 mm ² 047853	5 m, air, ø 70 mm ² 034839	350 A, 4 m, air 040946	350 A, 3 m, air 040731

PROMIG 400 G.DV WS

	pack PROMIG 400 G.DV WS 1 062764 5 068,00 €HT	TF-4W 061705	Ø1/1.2 (original equipment)	4m, 50 mm ² 047853	5 m, liquid, ø 70 mm ² 033641	500 A, 4 m, liquid 041004	
	pack PROMIG 400 G.DV WS 2 062771 5 370,00 €HT	TF-4W 061705	Ø1/1.2 (original equipment)	4m, 50 mm ² 047853	10 m, liquid, ø 70 mm ² 033658	500 A, 4 m, liquid 041004	
	pack PROMIG 400 G.DV WS 3 062788 5 111,00 €HT	TF-4W 061705	Ø1/1.2 (original equipment)	Alu, Ø1/1.2 (x2) 040915	4m, 50 mm ² 047853	5 m, liquid, ø 70 mm ² 033641	500 A, 3 m, liquid 046160
	pack PROMIG 400 G.DV WS 4 062795 5 412,00 €HT	TF-4W 061705	Ø1/1.2 (original equipment)	Alu, Ø1/1.2 (x2) 040915	4m, 50 mm ² 047853	10 m, liquid, ø 70 mm ² 033658	500 A, 3 m, liquid 046160

MAGYS 400-4

			 TYPE C			 Fe/CrNi	 Alu
		pack MAGYS 400-4 1 032279		Ø1/1.2 (original equipment)	4m, 50 mm ² 047853		350 A, 4 m, air 040946
			Ø1/1.2 (original equipment)	Alu, Ø1/1.2 (x2) 042162	4m, 50 mm ² 047853		350 A, 3 m, air 040731

MAGYS 400-GR

	pack MAGYS 400 GR 1 032293	WS-4R 034723	Ø1/1.2 (original equipment)	4m, 50 mm ² 047853	10 m, air, ø 70 mm ² 034860	350 A, 4 m, air 040946	
	pack MAGYS 400 GR 2 032309	WS-4R 034723	Ø1/1.2 (original equipment)	Alu, Ø1/1.2 (x2) 042162	4m, 50 mm ² 047853	10 m, air, ø 70 mm ² 034860	350 A, 3 m, air 040731
	pack MAGYS 400 GR 4 036451	WS-4R 034723	Ø1/1.2 (original equipment)	4m, 50 mm ² 047853	5 m, air, ø 70 mm ² 034839	350 A, 4 m, air 040946	
	pack MAGYS 400 GR 3 032316	WS-4L 032835	Ø1/1.2 (original equipment)	4m, 50 mm ² 047853	10 m, air, ø 70 mm ² 034860	350 A, 4 m, air 040946	

MAGYS 500 GR

	pack MAGYS 500 GR 1 032323	WS-4R 034723	Ø1/1.2 (original equipment)	4m, 70 mm ² 043831	10 m, air, ø 95 mm ² 045941	450 A, 4 m, air 045392	
	pack MAGYS 500 GR 2 036468	WS-4R 034723	Ø1/1.2 (original equipment)	4m, 70 mm ² 043831	5 m, air, ø 70 mm ² 034839	450 A, 4 m, air 045392	

MAGYS 500 WS

	pack MAGYS 500 WS 1 032330	WS-4L 033573	Ø1/1.2 (original equipment)	4m, 70 mm ² 043831	10m, liquid, ø 70 mm ² 033658	500 A, 4 m, liquid 041004	
	pack MAGYS 500 WS 4 036475	WS-4L 033573	Ø1/1.2 (original equipment)	4m, 70 mm ² 043831	5m, liquid, ø 70 mm ² 033641	500 A, 4 m, liquid 041004	
	pack MAGYS 500 WS 2 032347	WS-4L 033573	Ø1/1.2 (original equipment)	Alu, Ø1/1.2 (x2) 042162	4m, 70 mm ² 043831	10m, liquid, ø 70 mm ² 033658	500 A, 3 m, liquid 046160
	pack MAGYS 500 WS 3 032354	WS-4L 032835	Ø0.8/1 (original equipment)	4m, 70 mm ² 043831	10m, liquid, ø 70 mm ² 033658	500 A, 4 m, liquid 041004	

Cooling liquid (not included)

5L
062511 **68,00 €HT**

10L
052246 **138,00 €HT**





EASYMIG

GMAW/FCAW MIG/MAG INVERTER

3
in 1

GAS
NO GAS
MMA



EASYMIG 85

85 A $\varnothing 100$
NO GAS



2.1 m, 10 mm² + 1.6 m, 10 mm²
065536 **386,00 €HT**

EASYMIG 110

110 A $\varnothing 100$
GAS NO GAS MMA



2 m + 1.6 m, 16 mm² + 1.6 m, 10 mm²
013599 **506,00 €HT**

EASYMIG 130

120 A $\varnothing 100$
GAS NO GAS MMA



120 A on 13 A fuse
2 m + 1.6 m, 16 mm² + 1.6 m, 10 mm²
032231 **574,00 €HT**
031869

EASYMIG 140

140 A $\varnothing 100$
GAS NO GAS MMA



140 A on 13 A fuse
2 m + 1.6 m, 16 mm² + 1.6 m, 10 mm²
032262 **661,00 €HT**
031876

EASYMIG 150

140 A $\varnothing 100/200$
GAS NO GAS MMA



140 A on 13 A fuse
2 m + 1.6 m, 16 mm² + 1.6 m, 10 mm²
032248 **719,00 €HT**
031883

EASYMIG 160

160 A $\varnothing 100/200$
GAS NO GAS MMA



2 m + 1.6 m, 16 mm² + 1.6 m, 16 mm²
032255 **850,00 €HT**

EASYMIG 160 XL

160 A $\varnothing 200/300$
GAS NO GAS MMA

2.5 m + 2 m, 16 mm² + 2 m, 16 mm²
013605 **963,00 €HT**

EASYMIG 180-4 XL

180 A $\varnothing 200/300$
GAS NO GAS MMA

3 m + 2 m, 16 mm² + 2 m, 16 mm²
066571 **1 024,00 €HT**

OPTIONS

KIT SOUDAGE NO GAZ Ø 0.9
- No Gas Welding Kit Ø 0.9
- Schweißset Fülldraht
NO GAS
more p.69



CE NORM. EN60974-1	MADE IN GYS CHINA	50/60 Hz	A	EURO	I ₂ MMA	I ₂ MIG	MIG EN60974-1 (40°C)		MMA EN60974-1 (40°C)		U ₀ (V)	Electronic Control	100 mm 1 kg	200 mm 5 kg	300 mm 15 kg	\varnothing mm			Equipment d'origine Original equipment Originalausstattung Equipamiento de fabrica	TYPE	cm	kg	
							IA (60%)	X% (I ₂ max)	IA (60%)	X% (I ₂ max)						GAS	NO GAS	MMA					
EASYMIG 85		230V 1~	16	—	—	30→85	50	85 A @ 20%	—	—	62		■	—	—	—	0.6+0.9	—	0.9 (no gas)	D-039476	8.0/0.9	—	9.5
EASYMIG 110		230V 1~	16	—	20→80	30→100	60	100 A @ 30%	50	80 A @ 30%	62		■	—	—	0.6+0.8	0.6+0.9	1.6+2.5	0.8 (gas) / 0.9 (no gas)	D-039476	8.0/0.9	41×42×19	9.5
EASYMIG 130		230V 1~	16	—	20→100	30→120	70	120 A @ 20%	60	100 A @ 20%	62		■	—	—	0.6+0.8	0.6+0.9	1.6+3.2	0.8 (gas) / 0.9 (no gas)	D-039476	8.0/0.9	43×42×19	10.5
EASYMIG 140		230V 1~	16	■	20→120	30→140	80	140 A @ 15%	70	120 A @ 15%	62		■	—	—	0.6+0.8	0.6+0.9	1.6+3.2	0.8 (gas) / 0.9 (no gas)	D-039476	8.0/0.9	43×42×19	11.3
EASYMIG 150		230V 1~	16	■	20→120	30→140	80	140 A @ 15%	70	120 A @ 15%	62		■	■	—	0.6+0.8	0.6+0.9	1.6+3.2	0.8 (gas) / 0.9 (no gas)	A-046856	8.0/0.9	52×36×25	13
EASYMIG 160		230V 1~	16	■	20→140	30→160	95	160 A @ 20%	90	140 A @ 20%	59		■	■	—	0.6+0.8	0.6+0.9	1.6+3.2	0.8 (gas) / 0.9 (no gas)	A-046856	8.0/0.9	50×36×25	14.3
EASYMIG 160 XL		230V 1~	16	■	20→140	30→160	95	160 A @ 20%	90	140 A @ 20%	59		—	■	■	0.6+0.8	0.6+0.9	1.6+3.2	0.8 (gas) / 0.9 (no gas)	A-046856	8.0/0.9	55×44×25	15.7
EASYMIG 180-4 XL		230V 1~	16	■	20→150	30→180	110	180 A @ 20%	100	150 A @ 20%	59		—	■	■	0.6+0.8	0.6+0.9	1.6+3.2	0.8 (gas) / 0.9 (no gas)	A-046856	8.0/0.9	55×44×25	15.7

EASYMIG
MIG/MAG • INVERTER





MULTEPEARL

GMAW/FCAW MIG/MAG INVERTER • SYNERGIC

4
in 1

GAS

NO GAS

MMA

TIG



Youtube

1 MIG / MANUAL

Enter your parameters



Adjust Spot & Delay

2 MIG / SYNERGIC

Easy to use

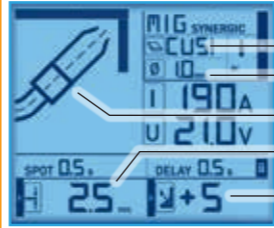

Select :

- 1. material → Fe CrNi
AlMg5 CuSi3
 - 2. Ø wire → AISi5 AISi12
 - 3. position → CuAl8 F.C.
 - 4. thickness : 0.5 → 6 mm
- Adjust arc length

3 MMA



HotStart ArcForce
Electrodes : Ø 1.6 → 5 mm

4 TIG lift



Post Gas Downslope
Thickness : 0.5 → 8 mm



230V 1~



10/25mm²
Ø 9 mm

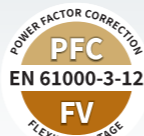

10/25mm²
Ø 9 mm

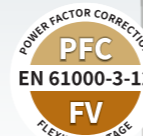

10/25mm²
Ø 9 mm

MULTEPEARL 210-2

200 A						
P400	PFC	FV	SR	HS	AF	Anti Sticking
GAS	NO GAS	MMA	TIG			

3 m 2.5 m, 16 mm² 2 m, 16 mm²
065093 1 519,00 €HT

MULTEPEARL 210-4 XL

200 A						
P400	PFC	FV	SR	HS	AF	Anti Sticking
GAS	NO GAS	MMA	TIG			

3 m 2.5 m, 16 mm² 2 m, 16 mm²
065109 1 656,00 €HT

MULTEPEARL 211-4

200 A						
P400	PFC	FV	SR	HS	AF	Anti Sticking
GAS	NO GAS	MMA	TIG			

3 m 2.5 m, 16 mm² 2 m, 16 mm²
065116 1 744,00 €HT

PFC POWER FACTOR CORRECTION

185 V ← 265 V

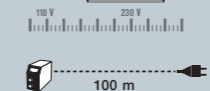

FV FLEXIBLE VOLTAGE

85 V ← 265 V



SR SECONDARY REGULATION

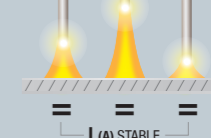

Anti Sticking

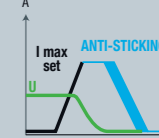

TIG torch kit SR17V (valve)
4 m
10/25mm²
044425 106,00 €HT

TIG torch kit SR17 DB
4 m
046108 183,00 €HT



KIT SOUDAGE NO GAZ Ø 0.9
- No Gas Welding Kit Ø 0.9
- Schweißset Fülldraht

NO GAS

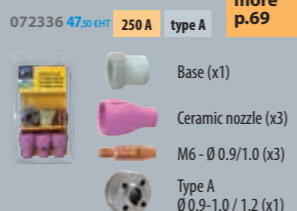

072336 47,50 €HT 250 A type A
more p.69

- Base (x1)
- Ceramic nozzle (x3)
- M6 - Ø 0.9/1.0 (x3)
- Type A Ø 0.9-1.0 / 1.2 (x1)

MADE IN FRANCE EN60974-1	50/60 Hz	I ₂			EN60974-1 (40°C)	U _o (V)	Electronic Control	MIG			GAS	NO GAS	MMA	TYPE	cm	kg	Protected & compatible power generator (+/-15%)			
		MMA	TIG	min → max				m/min	100 mm 1 kg	200 mm 5 kg								300 mm 15 kg		
Multi PEARL 210-2	110V 1~	32	10 → 130	10 → 160	20 → 150	100	150 A @ 22%	76	15	■	■	—	0.6 → 1.0	0.9 → 1.2	1.6 → 3.2	A	0.8/1.0	25 x 45 x 35	16	7.5 kW
	230V 1~	16	10 → 200	10 → 200	20 → 200	130	200 A @ 20%	75	15	■	■	■	0.6 → 1.0	0.9 → 1.2	1.6 → 5.0	A	0.8/1.0	25 x 45 x 35	16	7.5 kW
Multi PEARL 210-4 XL	110V 1~	32	10 → 130	10 → 160	20 → 150	100	150 A @ 22%	76	15	■	■	■	0.6 → 1.0	0.9 → 1.2	1.6 → 3.2	B	0.8/1.0	27.5 x 55 x 44	20	7.5 kW
	230V 1~	16	10 → 200	10 → 200	20 → 200	130	200 A @ 20%	75	15	■	■	■	0.6 → 1.0	0.9 → 1.2	1.6 → 5.0	B	0.8/1.0	27.5 x 55 x 44	20	7.5 kW
Multi PEARL 211-4	110V 1~	32	10 → 130	10 → 160	20 → 150	100	150 A @ 22%	76	15	■	■	■	0.6 → 1.0	0.9 → 1.2	1.6 → 3.2	B	0.8/1.0	41 x 73 x 77	27	7.5 kW
	230V 1~	16	10 → 200	10 → 200	20 → 200	130	200 A @ 20%	75	15	■	■	■	0.6 → 1.0	0.9 → 1.2	1.6 → 5.0	B	0.8/1.0	41 x 73 x 77	27	7.5 kW



GMAW/FCAW MIG/MAG INVERTER

3
in 1
GAS
NO GAS
MMA

IP 23 INDOOR /
OUTDOOR
✓ 220M-C
✓ 220M
✓ 320T-C

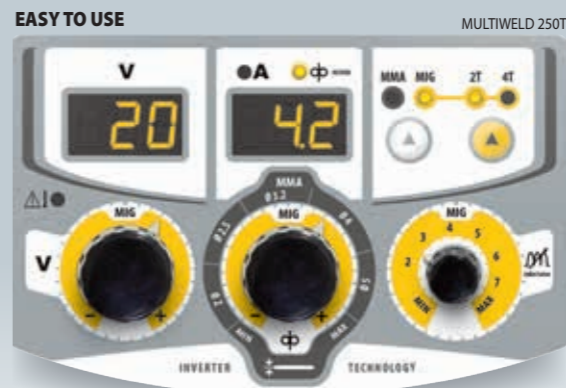

230V • 1~

400V • 3~

MULTIWELD 160M

230V • 1~
160 A ⚡ ⚡ ⚡ ⚡ ⚡
GAS NO GAS MMA
Anti Sticking

2.5 m 2 m, 16 mm² 2 m, 16 mm²
013612 1 163,00 €HT

MULTIWELD 200M-C

230V • 1~
200 A ⚡ ⚡ ⚡ ⚡ ⚡
GAS NO GAS MMA
Anti Sticking

2.5 m 2 m, 16 mm² 2 m, 16 mm²
066588

MULTIWELD 200M

230V • 1~
200 A ⚡ ⚡ ⚡ ⚡ ⚡
GAS NO GAS MMA
Anti Sticking

2.5 m 2 m, 16 mm² 2 m, 16 mm²
065499 1 463,00 €HT

MULTIWELD FV 220M-C

110V / 230V • 1~
220 A ⚡ ⚡ ⚡ ⚡ ⚡
GAS NO GAS MMA
Anti Sticking FV

3 m 2.5 m, 25 mm² 2 m, 25 mm²
065499 1 463,00 €HT

MULTIWELD FV 220M

110V / 230V • 1~
220 A ⚡ ⚡ ⚡ ⚡ ⚡
GAS NO GAS MMA
Anti Sticking FV

3 m 2.5 m, 25 mm² 2 m, 25 mm²
065482 1 506,00 €HT

MULTIWELD 250T-C

400V • 3~
250 A ⚡ ⚡ ⚡ ⚡ ⚡
GAS NO GAS MMA Anti Sticking

no accessories:
014572 1 474,00 €HT
4 m 4 m, 35 mm² 4 m, 25 mm²
062238 1 766,00 €HT Delivered in x4

MULTIWELD 250T

400V • 3~
250 A ⚡ ⚡ ⚡ ⚡ ⚡
GAS NO GAS MMA Anti Sticking

no accessories:
031678 1 549,00 €HT
4 m 4 m, 35 mm² 4 m, 25 mm²
014756 1 841,00 €HT Delivered in x4

MULTIWELD 320T-C

400V • 3~
320 A ⚡ ⚡ ⚡ ⚡ ⚡
GAS NO GAS MMA Anti Sticking

no accessories:
063037 1 836,00 €HT
4 m 4 m, 35 mm² 4 m, 35 mm²
065130 2 216,00 €HT Delivered in x4

MULTIWELD 320T

400V • 3~
320 A ⚡ ⚡ ⚡ ⚡ ⚡
GAS NO GAS MMA Anti Sticking

no accessories:
062467 1 890,00 €HT
4 m 4 m, 35 mm² 4 m, 35 mm²
065123 2 270,00 €HT Delivered in x4

OPTIONS

KIT SOUDAGE NO GAZ Ø 0.9 - No Gas Welding Kit Ø 0.9 - Schweißset Fülldraht

250 A type A 072336 47 €HT
250 A type B 072343 65 €HT

NO GAS
more
p.69

CO2 Gas heater and regulator

MULTIWELD only
AC36V/150W

RH-258, G5/8 CN 063341
GH-258, G3/4 Russia 063358
GH-258, G7/8 UK 063365



- Base
- Ceramic nozzle (x3)
- M6 - Ø 0.9/1.0 (x3)
- Type B Ø 0.9-1.0 / 1.2 (x2)

EN60974-1	MADE IN GYS CHINA	EN60974-1 (40°C)				I ₂ MMA	I ₂ MIG	EN60974-1 (40°C)				U ₀ (V)	Electronic Control	200 mm 5 kg	300 mm 15 kg	Ø mm		Equipment d'origine Original equipment Originalausstattung Equipamiento de fabrica	wheels	cm	kg	Protected & compatible power generator (+/-15%)		
		MIG	MMA	GAS	NO GAS			MMA	TYPE															
MULTIWELD 160M	230V 1~	3x 1.5	2	16	■	20 → 140	30 → 160	95	160 A @ 20%	90	140 A @ 20%	59	■	■	0.6 → 0.8	0.9	1.6 → 3.2	0.8 (gas) / 0.9 (no gas)	A-046856	0.8	■	79 × 77 × 47	30	5 kW
MULTIWELD 200M-C	230V 1~	3x 2.5	2	16	■	20 → 180	30 → 200	115	200 A @ 15%	104	200 A @ 15%	65	■	■	0.6 → 1.2	0.9 → 1.2	1.6 → 4	0.8/1.0	A-041189	—	—	58 × 52 × 34	—	9 kW
MULTIWELD 200M	230V 1~	3x 2.5	2	16	■	20 → 180	30 → 200	115	200 A @ 15%	104	200 A @ 15%	65	■	■	0.6 → 1.2	0.9 → 1.2	1.6 → 4	0.8/1.0	A-041189	—	■	79 × 77 × 47	—	9 kW
MULTIWELD FV 220M-C	110V 1~ / 230V 1~	3x 2.5	2	16	■	30 → 200	30 → 220	160	220 A @ 20%	140	200 A @ 20%	75	■	■	0.6 → 1.2	0.9 → 1.2	1.6 → 5	0.8/1.0	A-041189	—	—	58 × 52 × 34	24	9 kW
MULTIWELD FV 220M	110V 1~ / 230V 1~	3x 2.5	2	16	■	30 → 200	30 → 220	160	220 A @ 30%	140	200 A @ 20%	75	■	■	0.6 → 1.2	0.9 → 1.2	1.6 → 5	0.8/1.0	A-041189	—	■	79 × 77 × 47	32	9 kW
MULTIWELD 250T-C	400V 3~	4x 1.5	3	16	■	40 → 220	40 → 250	170	250 A @ 20%	150	220 A @ 20%	59	■	■	0.6 → 1.2	0.9 → 1.2	1.6 → 5	0.8/1.0	A-041189	—	—	58 × 52 × 32	32	9 kW
MULTIWELD 250T	400V 3~	4x 1.5	3	16	■	40 → 250	40 → 250	200	250 A @ 30%	200	250 A @ 30%	59	■	■	0.6 → 1.2	0.9 → 1.2	1.6 → 5	0.8/1.0	A-041189	—	■	79 × 77 × 47	40	9 kW
MULTIWELD 320T-C	400V 3~	4x 2.5	3	16	■	40 → 300	40 → 320	200	320 A @ 20%	180	300 A @ 20%	59	■	■	0.6 → 1.2	0.9 → 1.2	1.6 → 6	0.8/1.0	B-042360	—	—	58 × 52 × 34	38	13 kW
MULTIWELD 320T	400V 3~	4x 2.5	3	16	■	40 → 300	40 → 320	240	320 A @ 30%	220	300 A @ 30%	59	■	■	0.6 → 1.2	0.9 → 1.2	1.6 → 6	0.8/1.0	B-042360	—	■	77 × 79 × 47	44	13 kW

MIG WIRE FEEDER



EXAFEED 4L
032408

AIR LIQUID

PUSH PULL COMPATIBILITY

CONNECTION CABLE



AIR COOLED

- 5 m 70 mm² 047587 570.00 eHT
- 10 m 70 mm² 047594 848.00 eHT
- 10 m 95 mm² 047600 993.00 eHT
- 15 m 95 mm² 038349 1461.00 eHT
- 20 m 95 mm² 038431 2110.00 eHT

LIQUID COOLED

- 1.8 m 70 mm² 037243 469.00 eHT
- 5 m 70 mm² 047617 676.00 eHT
- 10 m 70 mm² 047624 1018.00 eHT
- 10 m 95 mm² 047631 1144.00 eHT
- 15 m 95 mm² 038448 1569.00 eHT
- 20 m 95 mm² 038455 2231.00 eHT

ROLLERS

047020 109.00 eHT



SKIS

047037 64.00 eHT



REMOTE CONTROL

RC-HA2
10m (EXAFEED only)
047679



Push Pull (24V/42V)
Connector 14pt, male
047686 26.00 eHT



MADE IN FRANCE

EN60974-1 (40°C)	max	200 mm 5 kg	300 mm 15 kg	GAS NO GAS	1.0/1.2 mm	TYPE C-042117	70 x 51 x 38	20.5
IA (60%)	X% (I2 max)	Electronic Control	m/min	Ø mm				
500	60		22	0.6+1.6	0.9+2.4			

MIG PORTABLE FEEDER

UNIVERSAL
CHANTIER - JOBSITE

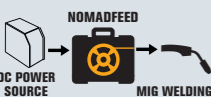

Ø 200/300 - 300
NOMADFEED 425-4 CC/CV
036291



OPTIONS

OPEN ARC

Adapter kit for self shielded flux-cored wires -
Adaptateur pour fil fourré sans gaz
068636 350.00 eHT



NOMADFEED CABLE

- 5 m 95 mm² 032439 254.00 eHT
- 10 m 95 mm² 032446 445.00 eHT
- 15 m 95 mm² 036666 635.00 eHT
- 20 m 95 mm² 036673 929.00 eHT



TIG HF



EXATIG HF
013780

UNIVERSAL

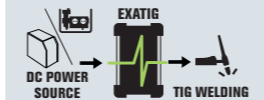

details p.25



EXAGON

7 in 1
MULTIPROCESS
INVERTER CC/CV

- MMA**
Kits MMA p. 19
- MMA • PULSE**
Kits MMA p. 19
- TIG DC LIFT**
Torches & consommables p. 33
- GOUGING**
Accessories p. 19
- MIG Wire feeder**
EXAFEED 4L
- MIG Portable feeder**
NOMADFEED 425-4 CC/CV
- TIG HF**
EXATIG



EXAGON 400 CC/CV

400 V • 3 ~ 400A
400A 60 %

SR VRD inside AD IP 23

no accessories
010925

VRD inside Voltage Reduction Device

MEMORY : 50 MMA JOBS + 50 TIG JOBS

QUICK ACCESS

Program charge mode easy

EASY USB UPDATE

DIRECT COMPUTER

ROBUST DESIGN



IP 23

INDOOR / OUTDOOR



V/A control Arcforce/Inductance control SECURITY Lock/Unlock parameters Remote control



70/95 mm²
Ø 13 mm

COMPLETE PACKS

EXAGON

pack	EXAFEED 4L	EXACOOOL	NOMADFEED	EXATIG HF	ROLLERS	SKIS	REMOTE CONTROL	Fe/CrNi
EXAGON MAG A1	032408	liquid not included	10 m, air, ø 70 mm ² 047594	013780	047020	047037	RC-HA1	350 A, 4 m, air 040946
EXAGON MAG A2	032408		5 m, air, ø 70 mm ² 047587	013780	047020	047037	RC-HA1	350 A, 4 m, air 040946
EXAGON MAG W1	032408	EXACOOOL 1000W 032422	10 m, liquid, ø 95 mm ² 047631	013780	047020	047037	RC-HA1	500 A, 4 m, liquid 041004
EXAGON MAG W2	032408	EXACOOOL 1000W 032422	5 m, liquid, ø 70 mm ² 047617	013780	047020	047037	RC-HA1	500 A, 4 m, liquid 041004
EXAGON MAG A5			NOMADFEED 425-4 036291	013780			RC-HA1	450 A, 4 m, air 045392
EXAGON MAG A6			NOMADFEED 425-4 036291	013780			RC-HA1	450 A, 4 m, air 045392

EN60974-1	MADE IN FRANCE	50/60 Hz	A	A	A	A	MMA/TIG/MIG EN60974-1 (40°C)	IA (60%)	X% (I2 max)	100%	Uo	cm	kg	Protected & compatible power generator (+/-15%)
EXAGON 400 CC/CV		400V 3~	32 A	20+400	5+400	15+400	400	60	350 A	84V	58 x 52 x 30	36	30 kW	36 kVA



NEOPULSE

GMAW/FCAW MIG/MAG INVERTER • PULSE

CUSTOMISATION

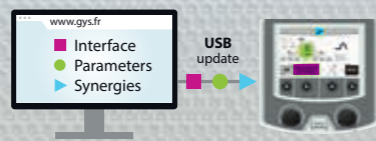

MIG Pulse

ACCESSIBILITY

- 3 interface levels
- EASY
 - ADVANCED
 - EXPERT
- 10 languages
- French
 - English
 - Italian
 - Spanish
 - Czech
 - Dutch
 - Russian
 - Chinese
 - Japanese



MIG Manual

MIG Standard



MIG

MANUAL	STANDARD DYNAMIC
SPOT	PULSE

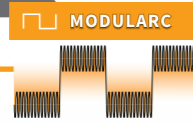

TIG

LIFT
PULSE

MMA

STANDARD
PULSE

GOUGING

Ø 4 > 6.4 (400G)
Ø 4 > 8 (500G)

MANUAL

QUICK LOAD

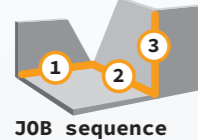

AUTOMATION

CONNECT 5

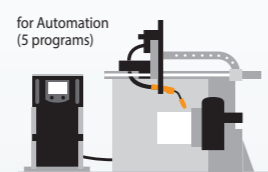

SAM

Automation module compatibility SAM-1N MIG/GMAW (details p.58)



CONNECTIVITY

TRACEABILITY

History data export

- Q MOS - WPQR
- D MOS - WPS

ENERGY CONTROL : 20 kHz, kJ or kJ/cm

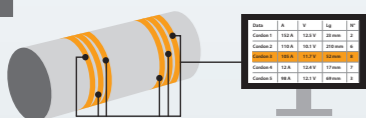

PORTABILITY

Share configuration & jobs

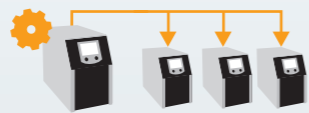

SOFTWARE UPDATE

Neopulse evolutions



Retrouvez toutes les synergies :
- Find all the synergies :
- Finde alle Synergien :

www.gys.fr

PFC POWER FACTOR CORRECTION

185 V - 265 V



IP 23 INDOOR / OUTDOOR



PFC EN 61000-3-12 POWER FACTOR CORRECTION

PFC EN 61000-3-12 POWER FACTOR CORRECTION



230 V • 1 ~

NEOPULSE 220 C

230 V • 1 ~

220 A



PFC AIR MMA TIG IP 23S

no accessories/no trolley
061835

NEOPULSE 220 C XL

230 V • 1 ~

220 A



PFC AIR MMA TIG IP 23S

no accessories/no trolley
061842

OPTIONS

USB key
16 Go/GB included
062344 32€ HT

Push Pull (24V/42V)
Connector 14pt, male
047686 26€ HT

JOBSITE XL
600 x 1150 x 584 mm
039568 423€ HT

CE NORM. EN60974-1 EN60974-5 EN60974-10	MADE IN FRANCE	50 / 60 Hz	A	A	PUSH/PULL	MIG EN60974-1 (40°C)		U _o	Electronic Control	m/min	GAS	NO GAS	200 mm 5 kg	300 mm 15 kg	Equipment d'origine Original equipment Originalausstattung Equipamiento de fabrica	TYPE	cm	kg	Protected & compatible power generator (+/-15%)	
						I (60%)	X% (I2 max)													100%
NEOPULSE 220 C		200 → 240 V • 1 ~	16	10 → 220	24V	150 A	20%	130 A	80 V	■	20	0.6 + 1.2	0.9 + 1.2	■	■	acier-steel 0.8 / 1.0 mm	B	55 × 41 × 32	28	7.5 kW
NEOPULSE 220 C XL		200 → 240 V • 1 ~	16	10 → 220	24V	150 A	20%	130 A	80 V	■	20	0.6 + 1.2	0.9 + 1.2	■	■	acier-steel 0.8 / 1.0 mm	B	32 × 49 × 60	30	7.5 kW



GMAW/FCAW MIG/MAG INVERTER • PULSE



NEOPULSE 320C, 400 CW & NEOFEED 4W



35/70 mm²
Ø 13 mm

OPTION
Cooling unit WCU 1kW C
1000 W, 5.5 l
liquid not included
013537

INCLUDED
Cooling unit
1000 W, 5.5 l
liquid not included

OPTION



Skate NEOPULSE 320 C (+WCU)
700 x 100 x 350 mm
037717 199,00 € HT

400 V • 3 ~

NEOPULSE 320 C

320 A ⚡ ⚡ ⚡ ⚡ ⚡ ⚡
AIR MMA TIG WF ✓
IP 23

no accessories/no trolley
062474

NEOPULSE 400 CW

400 A ⚡ ⚡ ⚡ ⚡ ⚡ ⚡ **400 A - 60%**
AIR LIQUID MMA TIG WF ✓
GOUGING AD IP 23

no accessories/no trolley
062061

400 V • 3 ~ • GENERATOR



NEOPULSE 400 G

400 A ⚡ ⚡ ⚡ ⚡ ⚡ ⚡ **400 A - 60%**
WF ✓ MMA TIG GOUGING
IP 23

no accessories/no trolley
014497



NEOPULSE 500 G

500 A ⚡ ⚡ ⚡ ⚡ ⚡ ⚡ **500 A - 50%**
WF ✓ MMA TIG GOUGING
IP 23

no accessories/no trolley
014503

CE NORM. EN60974-1 EN60974-5 EN60974-10	MADE IN FRANCE	50 / 60 Hz	A	min → max	PUSH/PULL	MIG EN60974-1 (40°C)			U _o	Electronic Control	m/min	GAS		NO GAS		200 mm 5 kg	300 mm 15 kg	Equipement d'origine Original equipment Originalausstattung Equipamiento de fabrica	TYPE	cm	kg	Protected & compatible power generator (+/-15%)
						I (60%)	X% (I2 max)	100%				Ømm	Ømm									
NEOPULSE 320 C		400 V - 3 ~	25	10 → 320	24/42 V	300 A	40%	280 A	85 V	■	22	0.6 + 1.2	0.9 + 1.6	■	■	acier-steel 1/1.2 mm	F (061873)	30 × 68 × 55	37	13 kW		
NEOPULSE 400 CW		400 V - 3 ~	32	10 → 400	24/42 V	400 A	60%	360 A	85 V	■	22	0.6 + 1.6	0.9 + 2.4	■	■	acier-steel 1/1.2 mm	F (061873)	96 × 51 × 85	78	20 kW		

CE NORM. EN60974-1	MADE IN FRANCE	50 / 60 Hz	A	min → max	PUSH/PULL	EN60974-1 (40°C) MIG			U _o	cm	kg	Protected & compatible power generator (+/-15%)
						I (60%)	X% (I2 max)	100%				
NEOPULSE 400 G		400 V - 3 ~	32	10 → 400	—	400 A	60%	360 A	85 V	68 × 30 × 42	31	20 kW
NEOPULSE 500 G		400 V - 3 ~	32	10 → 500	—	470 A	50%	440 A	85 V	68 × 30 × 42	32	25 kW



NEOPULSE 220C

pack NEOPULSE 220C A1 062801			TYPE B, Ø 0.8/1 (x2) (Original Equipment)	4 m, 35 mm ² 043817		250 A, 3 m, air 040700	
pack NEOPULSE 220C A2 062818			TYPE B, Ø 0.8/1 (x2) (Original Equipment)	TYPE B, Alu, Ø 1/1.2 (x2) 040915	4 m, 35 mm ² 043817		250 A, 3 m, air 040724



NEOPULSE 220C XL

pack NEOPULSE 220C XL A1 062825			TYPE B, Ø 0.8/1 (x2) (Original Equipment)	4 m, 35 mm ² 043817		250 A, 4 m, air 040922	
pack NEOPULSE 220C XL A2 062832			TYPE B, Ø 0.8/1 (x2) (Original Equipment)	TYPE B, Alu, Ø 1/1.2 (x2) 040915	4 m, 35 mm ² 043817		250 A, 3 m, air 040724



NEOPULSE 320C

pack NEOPULSE 320C A1 062849			TYPE F, Ø 1/1.2 (x4) (Original Equipment)	4m, 70 mm ² 036994		350 A, 4 m, air 040946	
pack NEOPULSE 320C A2 062856			TYPE F, Ø 1/1.2 (x4) (Original Equipment)	TYPE F, Alu, Ø 1/1.2 (x4) 061903	4m, 70 mm ² 036994		350 A, 3 m, air 040731
pack NEOPULSE 320C W1 062863	WCU 1kW C 013537		TYPE F, Ø 1/1.2 (x4) (Original Equipment)	4m, 70 mm ² 036994	T/M 400 037328		300 A, 4 m, liquid 043275
pack NEOPULSE 320C W2 062870	WCU 1kW C 013537		TYPE F, Ø 1/1.2 (x4) (Original Equipment)	TYPE F, Alu, Ø 1/1.2 (x4) 061903	4m, 70 mm ² 036994	T/M 400 037328	
pack NEOPULSE 320C W3 063402	WCU 1kW C 013537		TYPE F, Ø 1/1.2 (x4) (Original Equipment)	TYPE F, Alu, Ø 1/1.2 (x4) 061903	4m, 70 mm ² 036994	Skate 037717	300 A, 3 m, liquid 040748

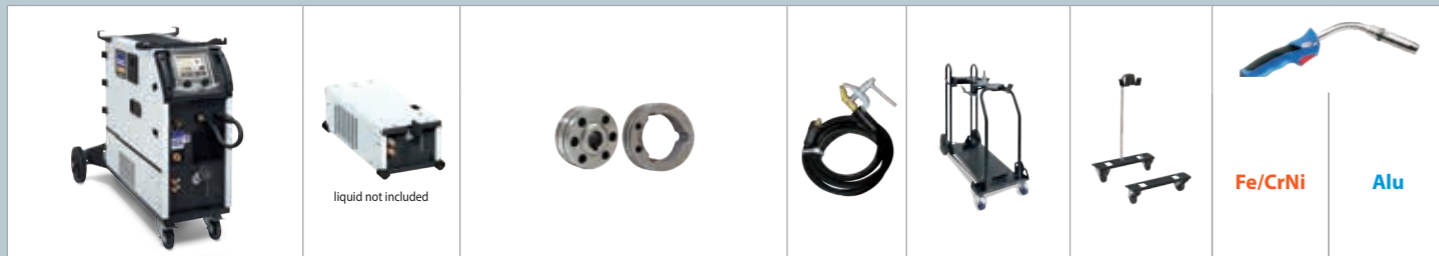

NEOPULSE 400CW

pack NEOPULSE 400CW 1 071483					4m, 70 mm ² 043831		500 A, 4 m, liquid 041004
pack NEOPULSE 400CW 2 071490			TYPE F, Alu, Ø 1/1.2 (x4) 061903		4m, 70 mm ² 043831		500 A, 3 m, liquid 046160



NEOPULSE 400G

pack NEOPULSE 400G A1 062887	NEOFEED 4W 014527			5 m, air, ø 70 mm ² 047587	TYPE F, Ø 1/1.2 (x4) (Original Equipment)	4m, 70 mm ² 043831	T/M 400 037328		450 A, 4 m, air 045392
pack NEOPULSE 400G W1 062894	NEOFEED 4W 014527		NEOCOOL 1000W 032750	10 m, liquid, ø 95 mm ² 047631	TYPE F, Ø 1/1.2 (x4) (Original Equipment)	4m, 70 mm ² 043831	T/M 400 037328		500 A, 4 m, liquid 041004
pack NEOPULSE 400G W2 062900	NEOFEED 4W 014527		NEOCOOL 1000W 032750	10 m, liquid, ø 95 mm ² 047631	TYPE F Ø 1/1.2 (x4) (Original Equipment)	TYPE F, Alu Ø 1/1.2 (x4) 061903	4m, 70 mm ² 043831	T/M 400 037328	
pack NEOPULSE 400G W3 066533	x2 NEOFEED 4W 014527		TWINCOOL 1000W 065086	x2 10 m, liquid, ø 95 mm ² 047631	TYPE F Ø 1/1.2 (x4) (Original Equipment)	TYPE F, Alu Ø 1/1.2 (x4) 061903	4m, 70 mm ² 043831	T/M 400 037328	fixation kit 064690
pack NEOPULSE 400G W4 066540	x2 NEOFEED 4W 014527	x2 Rollers 047020	TWINCOOL 1000W 065086	x2 10 m, liquid, ø 95 mm ² 047631	TYPE F Ø 1/1.2 (x4) (Original Equipment)	TYPE F, Alu Ø 1/1.2 (x4) 061903	4m, 70 mm ² 043831		Pallet trolley 064621
pack NEOPULSE 400G W5 072718	NEOFEED 4W 014527		NEOCOOL 1000W 032750	10 m, liquid, ø 70 mm ² 047624	TYPE F, Ø 1/1.2 (x4) (Original Equipment)			T/M 400 037328	
pack NEOPULSE 400G W6 072725	NEOFEED 4W 014527		NEOCOOL 1000W 032750	10 m, liquid, ø 70 mm ² 047624	TYPE F, Ø 1/1.2 (x4) (Original Equipment)	4m, 50 mm ² 047853		T/M 400 037328	500 A, 4 m, liquid 041004
pack NEOPULSE 400G W7 072732	NEOFEED 4W 014527		NEOCOOL 1000W 032750	10 m, liquid, ø 70 mm ² 047624	TYPE F Ø 1/1.2 (x4) (Original Equipment)	TYPE F, Alu Ø 1/1.2 (x4) 061903	4m, 50 mm ² 047853	T/M 400 037328	500 A, 3 m, liquid 046160



NEOPULSE 500G

pack NEOPULSE 500G A1 062917	NEOFEED 4W 014527			10 m, air, ø 95 mm ² 047600	TYPE F, Ø 1/1.2 (x4) (Original Equipment)		4m, 95 mm ² 047013	T/M 400 037328		450 A, 4 m, air 045392
pack NEOPULSE 500G W1 062924	NEOFEED 4W 014527		NEOCOOL 1000W 032750	10 m, liquid, ø 95 mm ² 047631	TYPE F, Ø 1/1.2 (x4) (Original Equipment)		4m, 95 mm ² 047013	T/M 400 037328		500 A, 4 m, liquid 041004
pack NEOPULSE 500G W2 062931	NEOFEED 4W 014527		NEOCOOL 1000W 032750	10 m, liquid, ø 95 mm ² 047631	TYPE F Ø 1/1.2 (x4) (Original Equipment)	TYPE F, Alu Ø 1/1.2 (x4) 061903	4m, 95 mm ² 047013	T/M 400 037328		500 A, 3 m, liquid 046160
pack NEOPULSE 500G W3 066557	x2 NEOFEED 4W 014527		TWINCOOL 1000W 065086	x2 10 m, liquid, ø 95 mm ² 047631	TYPE F Ø 1/1.2 (x4) (Original Equipment)	TYPE F, Alu Ø 1/1.2 (x4) 061903	4m, 95 mm ² 047013	T/M 400 037328	fixation kit 064690	500 A, 4 m, liquid 041004
pack NEOPULSE 500G W4 066564	x2 NEOFEED 4W 014527	x2 Rollers 047020	TWINCOOL 1000W 065086	x2 10 m, liquid, ø 95 mm ² 047631	TYPE F Ø 1/1.2 (x4) (Original Equipment)	TYPE F, Alu Ø 1/1.2 (x4) 061903	4m, 95 mm ² 047013		Pallet trolley 064621	500 A, 4 m, liquid 041004



INTEGRATION



ONLINE CONFIGURATION GUIDE

	I (100%)	Integrated wirefeeder	SAM-1A (Analogic/Digital)	SAM-1N (Numerical)
MIG/MAG - GMAW/FCAW				
NEOPULSE 320 C	280 A	✓	✓	✓
NEOPULSE 400 CW	360 A	✓	✓	✓
NEOPULSE 400 G	360 A	–	✓	✓
NEOPULSE 500 G	440 A	–	✓	✓
TIG - GTAW				
TITAN 400 DC	360 A	–	✓	✓
TITANIUM 230 AC/DC	170 A	–	–	✓
TITANIUM 400 AC/DC	360 A	–	✓	✓

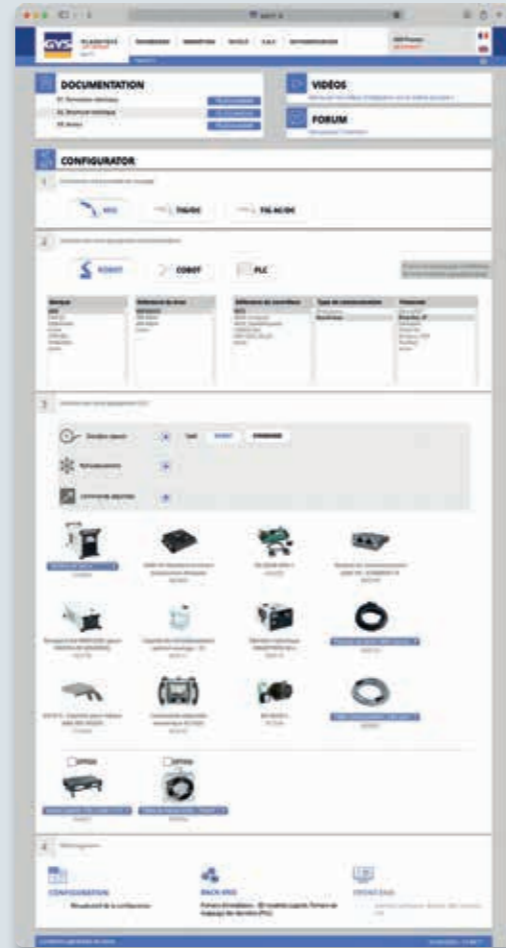

ROBOT	COBOT	PLC
KAWASAKI ✓✓	UNIVERSAL ROBOTS ✓✓	PROFACE ✓✓
ABB ✓✓	TECHMEN ROBOT ✓✓	SCHNEIDER ELECTRIC ✓✓
FANUC ✓✓	DOOSAN ✓✓	SIEMENS ✓✓
KUKA ✓✓	HANWHA ✓✓	ROCKWELL AUTOMATION ✓✓
STÄUBLI ✓✓	JAKA ✓✓	WAGO ✓✓
YASKAWA ✓✓	OMRON ✓✓	UNITRONICS ✓✓
...	...	BECKHOFF ✓✓

Complete with -
Completez avec



Complete configuration

A summary of the requested set-up configuration as an Excel file along with a list of the GYS equipments needed to automate it.
- Récapitulatif de la configuration souhaitée au format Excel avec les équipements GYS nécessaires à l'automatisation.



Back-End

Zip file with :

- 3D models (.step)
- IP configuration
- Software
- Electronic files



Front-End

User interfaces :

- URcap software
- More on demand...



AUTOMATION MODULE

- 1 MACHINE CONNECTIVITY KITS
- 2 SMART AUTOMATION MODULE SAM 1N 064935
- 3 ANYBUS CONNECTORS



KIT NUM TIG/GTAW 1
for TITAN 400 DC & TITANIUM 400 AC/DC
037960

KIT NUM MIG/GMAW 1
for NEOPULSE 320C, 400 CW, 400G & 500G
062993



Ethernet IP	062078
Profinet	062085
Modbus TCP	063013
Devicenet	062092
Can Open	062108
Ethercat	063006

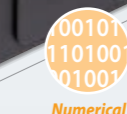

Numerical

POWER SOURCE · PLC/ROBOT/COBOT CONNECTION



- 1 SMART AUTOMATION MODULE SAM 1A 071940



Analogic / Digital



8 inputs
7 outputs



Integrated SAFETY function



3 modes:
Job, Manual,
Tracking

POWER SOURCE · PLC/ROBOT/COBOT CONNECTION

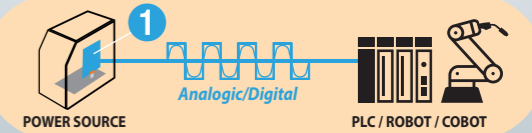

ROBOTIC WIRE FEEDER

- 4 SMARTFEED M-4 IP 21 066618

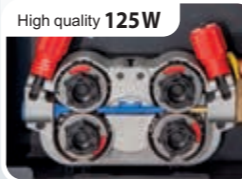

15 cm

24.5 cm

21.5 cm

Front view



Back view



ULTRA LIGHT
4.5 kg



VIBRATION & SHOCK RESISTANT

POWER SOURCE · PLC/ROBOT/COBOT CONNECTION

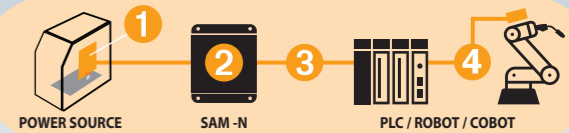

EN60974-1 (40°C)		Equipement d'origine - Original equipment Originalausrüstung - Equipamiento de fabrica		max	PUSH-PULL		Ø mm		cm		kg
IA 60%	X% I2 max	Electronic Control		TYPE	m/min		GAS NO GAS		24.5 × 15 × 21.5		4.5
500	60			1.0 / 1.2 mm	F-061873	1 + 25	0.6 + 1.6 0.9 + 2.4				

Options

Robotic MIG connection cables Liquid, 4 m, Ø 95mm² 073517

Robotic MIG connection cables Liquid, 8 m, Ø 95mm² 069725



Command cable 4 m 073524

Command cable 8 m 073531



Smartfeed support for ROBOT kits

Kit n°1	070707 113.00 €HT	<ul style="list-style-type: none"> ✓ ABB ✓ YASKAWA ✓ KUKA ✓ FANUC ✓ KAWASAKI
Kit n°2	071445 113.00 €HT	
Kit n°3	071452 113.00 €HT	
Kit n°4	071469 113.00 €HT	
Kit n°5	071476 113.00 €HT	
Kit n°6	071476 113.00 €HT	
Kit n°7	072602 113.00 €HT	

MORE COMING SOON

Compatibilities on demand -
Compatibilités sur demande -
Kompatibilitäten auf Anfrage





PACKS



More configurations -
Plus de configurations



- TIG BTAW
- MIG/MAG GMAW/FCAW
- PLASMA CUTTING

COBOT

- ✓ HANWHA
- ✓ DOOSAN
- ✓ TECHMAN
- ✓ UNIVERSAL ROBOT
- ✓ OMRON

PACK NEOPULSE 320C A3 COBOT 067905

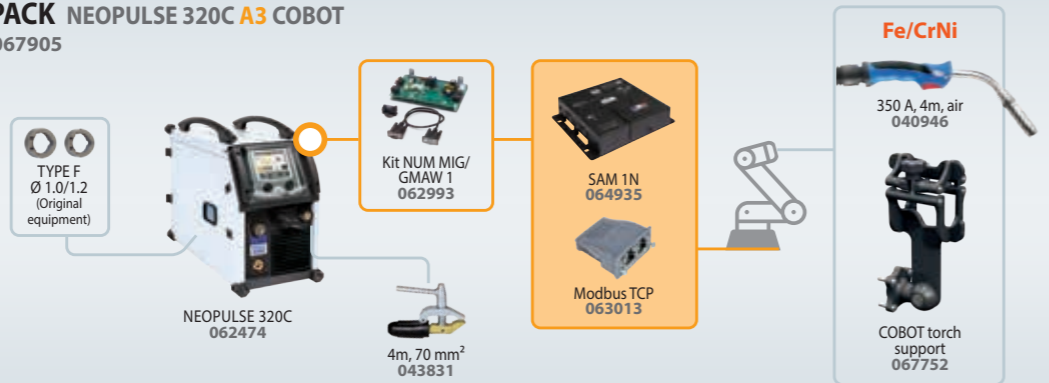

PACK NEOPULSE 320C W4 COBOT 067912

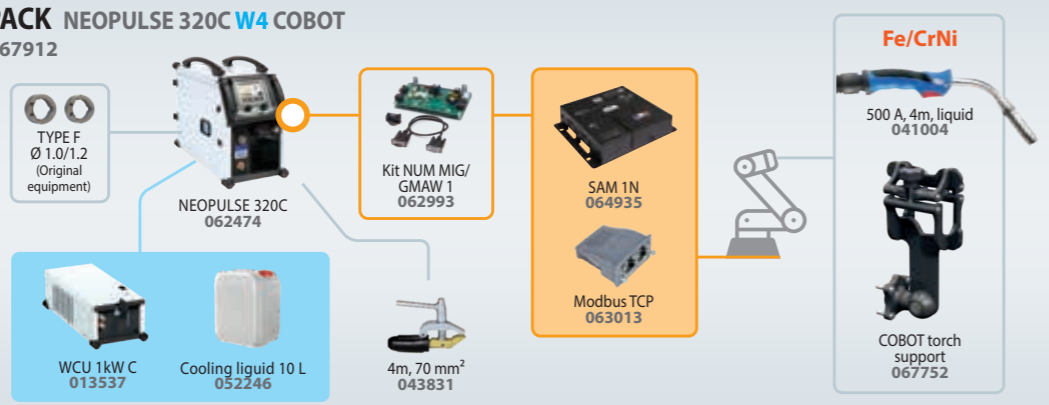

PACK NEOPULSE 400 CW 3 COBOT 071506

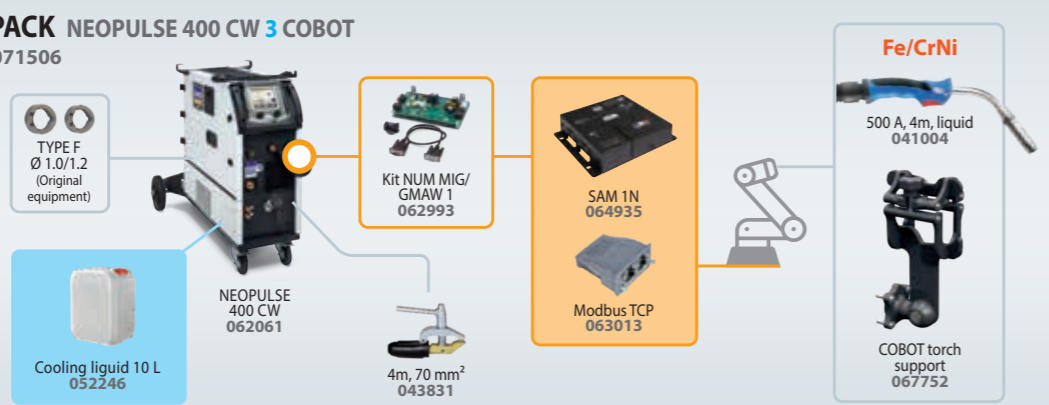

ROBOT

- ✓ ABB
- ✓ FANUC
- ✓ KAWASAKI
- ✓ KUKA
- ✓ YASKAWA
- ✓ STÄUBLI

PACK 1 NEOPULSE 400G ETHERNET IP 071575



PACK 2 NEOPULSE 500G ETHERNET IP 071582

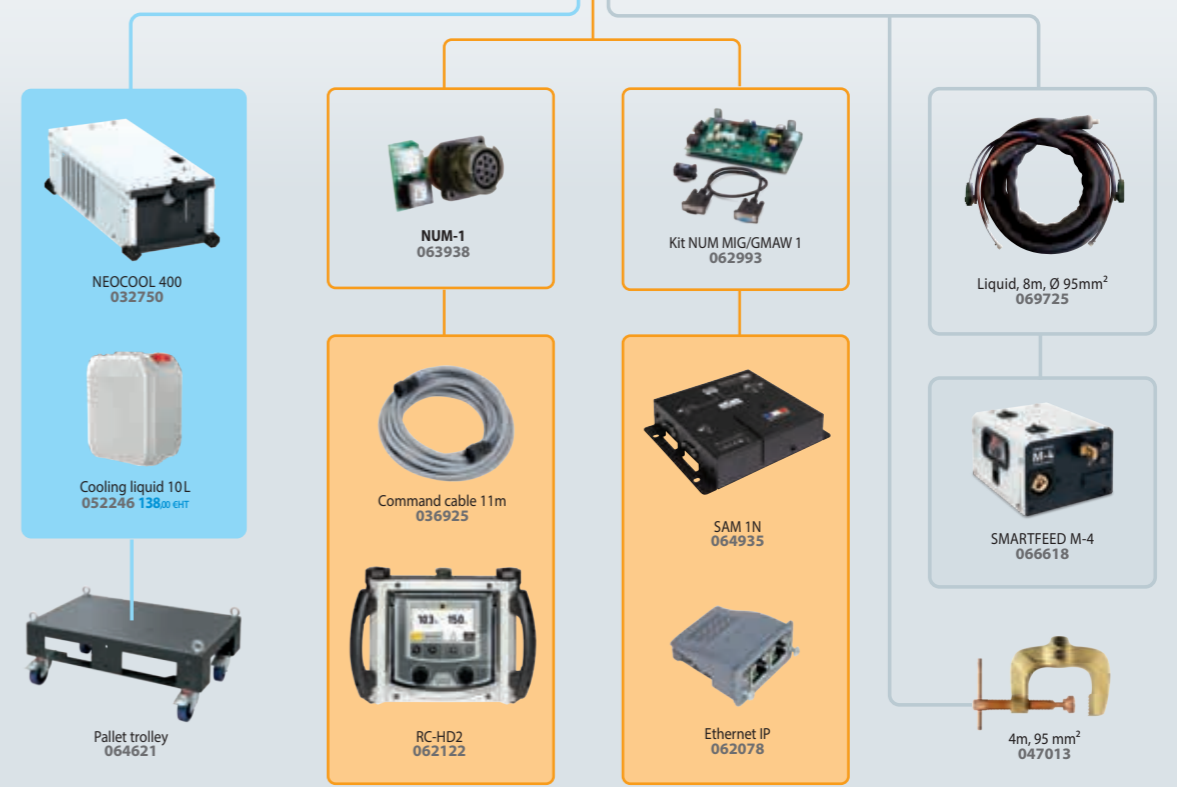

BOBINES DE FIL - Welding wire reels - Massivdrahtspulen - Rollos de hilo - Draadbobijn - Bobines de fio

bobine écologique / ecological wire reel

for	kg	Ø	EXCELLIUM					NORMES - Norms - Normen - Norma													
			Ø 0.6 mm	Ø 0.8 mm	Ø 0.9 mm	Ø 1.0 mm	Ø 1.2 mm	Ø 0.8 mm	Ø 1.0 mm	Ø 1.2 mm	AWS	EN	DIN								
Acier - Steel - Stahl - Acero - Staal - Aço	SG2	0.9	100 mm	086593 11.00 €HT	086609 10.00 €HT																
		5	200 mm	086111 37.00 €HT	086128 30.00 €HT		086135 29.00 €HT														
		15	300 mm	086166 95.00 €HT	086227 82.00 €HT		086234 77.00 €HT		086241 75.00 €HT		086302 92.00 €HT	086319 90.00 €HT									
	SG1	5	200 mm	086418 41.00 €HT	086401 33.00 €HT		086258 198.00 €HT														
		15	300 mm				086203 93.00 €HT														
		5	200 mm																		
	Fil fourré, Cored wire, Fülldraht, Hilo tubular NO GAS	0.9	100 mm	086425 28.00 €HT		086104 18.00 €HT															
		4.5	200 mm			086265 78.00 €HT		086623 79.00 €HT		086630 75.00 €HT											
		15	300 mm					086388 203.00 €HT		086395 218.00 €HT											
		Rechargement Acier 60 HRC - Hardfacing	16	300 mm							086173 351.00 €HT										
			5	200 mm	086760 92.00 €HT	086777 71.00 €HT															
		Galva (G2Ti)	1	100 mm																	
	CuSi3 HLE - UHTS (Boron Steel)	5	200 mm								086210 325.00 €HT										
		5	200 mm																		
		5	200 mm																		
CuAl8 HLE - UHTS (Boron Steel)	15	300 mm																			
	1	100 mm																			
	5	200 mm																			
Inox - Stainless steel - Edelstahl	CrNi (308LSi)	1	100 mm																		
	5	200 mm																			
	15	300 mm																			
CrNi (316LSi)	5	200 mm																			
	15	300 mm																			
	15	300 mm																			
Aluminium	AlMg2.7Mn	2	200 mm																		
		7	300 mm																		
		7	300 mm																		
	AlMg5	0.5	100 mm																		
		2	200 mm																		
		7	300 mm																		
	AlSi5	7	300 mm																		
		0.5	100 mm																		
		2	200 mm																		
	AlSi12	0.5	100 mm																		
		2	200 mm																		
		7	300 mm																		
AlSi10Cu4	2	200 mm																			

ADAPTATEURS BOBINES - Adaptors for wire reels - Korbspulenadapter

ALIGNER 200
Ø 200
042889 4.00 €HT

ECO ADAPTER 300
Intensive pour bobine écologique - for ecological wire reel - für Eco Fülldrahtrolle
043305 14.00 €HT

After sales

Professional 71608 Ø 200 & 300

Industrial 71613 Ø 200 & 300

Press & Lock

Guide fil - Guide Tube Kit
Ø 0.6 x 1.6 061965 20.00 €HT
Ø 1.8 x 2.8 061972 20.00 €HT

GALETS - Rollers - Drahtführungsrollen - Rollen - Rodillos - Wielen - Roletes

	TYPE A	TYPE B	TYPE C	TYPE D	TYPE E	TYPE F	
	Smartmig 142/152/162/182/183, Monogys 200-4, EasyMIG 150/160/160XL/180-4XL, Multiplearl 210-2, Multweld 160/200/220/250	Monogys 250-4/320-4, Trimig, Promig, TF-4R/4W, WWSS-4L, Multiplearl 210-4 XL/211-4, Multiweld 320, Neopulse 220	Magys 400-4, W5-4L/4R, Nomadfeed (down), Exafeed, Neopulse 300	Smartmig 110, EasyMIG 85/110/130/140	Nomadfeed (UP)	Neofeed, Neopulse 320C/400CW, Smartfeed M-4	
Acier - Steel - Stahl - Acero - Staal - Aço - Inox - Stainless	Ø 0.6 / 0.8 x1 042339 15.00 €HT Ø 0.8 / 1.0 x1 041189 15.00 €HT Ø 1.0 / 1.2 x1 062221 15.00 €HT Ø 1.2 / 1.4 x1 062221 15.00 €HT Ø 1.2 / 1.6 x1 062221 15.00 €HT	x1 042087 18.00 €HT x2 042353 29.00 €HT x1 042100 18.00 €HT x2 042360 29.00 €HT x1 042179 18.00 €HT x2 046849 29.00 €HT x2 042384 29.00 €HT x2 041752 28.00 €HT	x2 041738 28.00 €HT x2 042094 28.00 €HT x2 042117 28.00 €HT x2 039780 28.00 €HT x2 041752 28.00 €HT x2 042148 29.00 €HT x2 042162 29.00 €HT x2 041776 29.00 €HT	x1 039483 20.00 €HT	x2 061859 65.00 €HT x4 061866 65.00 €HT x4 061873 65.00 €HT x4 061880 65.00 €HT x4 061897 65.00 €HT x4 061903 65.00 €HT x4 061910 65.00 €HT	x4 061859 65.00 €HT x4 061866 65.00 €HT x4 061873 65.00 €HT x4 061880 65.00 €HT x4 061897 65.00 €HT x4 061903 65.00 €HT x4 061910 65.00 €HT	
Alu	x1 041196 15.00 €HT x1 062214 15.00 €HT	x1 042155 17.00 €HT x1 042186 17.00 €HT	x2 042377 29.00 €HT x2 040915 29.00 €HT x2 042391 29.00 €HT	x1 039469 20.00 €HT	x2 01.0 038578 34.00 €HT x2 01.2 038585 34.00 €HT x2 01.6 038592 34.00 €HT	x4 061880 65.00 €HT x4 061897 65.00 €HT x4 061903 65.00 €HT x4 061910 65.00 €HT	
Fil fourré - Cored wire	Ø 0.6 / 0.9 x1 068933 21.00 €HT Ø 0.8 (solid) / 0.9 (cored) x1 046856 21.00 €HT Ø 0.9 / 1.0 x1 042346 21.00 €HT Ø 1.2 / 1.4 x1 042131 22.00 €HT Ø 1.2 / 1.6 x1 042407 38.00 €HT Ø 1.6 / 2.0 x1 042131 22.00 €HT Ø 1.8 / 2.0 x1 042407 38.00 €HT	x1 068940 22.00 €HT	x2 042124 38.00 €HT x4 047693 81.00 €HT x2 038646 38.00 €HT x2 037113 38.00 €HT x4 040519 81.00 €HT x2 061743 38.00 €HT	x1 068926 20.00 €HT x1 039476 20.00 €HT x1 044081 13.00 €HT	x2 01.2 038608 37.00 €HT x2 01.6 038615 37.00 €HT x2 01.8 061750 37.00 €HT x2 02.0 037106 37.00 €HT x2 02.4 038622 37.00 €HT	x4 01.0/1.1 061927 87.00 €HT x4 01.2/1.6 061934 87.00 €HT x4 01.4/2.0 061941 87.00 €HT x4 01.6/2.4 061958 87.00 €HT	x4 061859 65.00 €HT x4 061866 65.00 €HT x4 061873 65.00 €HT x4 061880 65.00 €HT x4 061897 65.00 €HT x4 061903 65.00 €HT x4 061910 65.00 €HT

PINCE SPÉCIALE MIG/MAG - ORIGINAL FIX
- Special MIG/MAG pincer - Spezial MIG/MAG Zange
- Pinza especial MIG/MAG

PRO (x1) 041332 35.00 €HT

1) Clean 2) Cut 3&4) Prepare (Contact tip & Nozzle)

Support torche magnétique
- MIG torch stand with magnetic base - MIG-Brennerhalter mit Magnetfuß
041653 11.00 €HT

Liquide anti-grattons
- Anti spatter fluid - Antihafmittel
10L 054134 75.00 €HT

Pâte anti-adhérente
- Anti spatter paste - Antihaf-Paste
300g 054110 7.00 €HT

Pulvérisateur métallique
- Metallic spray bottle - Metallische Sprühflasche
054127 10.00 €HT

Spray protection céramique
- Ceramic protective spray - Keramisches Schutzspray
054141 29.00 €HT

Spray protecteur (sans silicone)
- Anti-spatter spray (without silicone)
041806 4.00 €HT

KITS SOUDAGE NO GAS - No Gas Welding Kits

041240 23.00 €HT 150 A type A

Isolated Nozzle (x1)
M6 - Ø 0.9/1.0 (x3)
Type A
Ø 0.9-1.0 / 1.2 (x1)

072329 27.00 €HT 250 A

Base (x1)
Ceramic nozzle (x3)
M6 - Ø 0.9/1.0 (x3)
Type A
Ø 0.9-1.0 / 1.2 (x1)

072336 47.00 €HT 250 A type A

Base (x1)
Ceramic nozzle (x3)
M6 - Ø 0.9/1.0 (x3)
Type A
Ø 0.9-1.0 / 1.2 (x1)

072343 65.00 €HT 250 A type B

Base (x1)
Ceramic nozzle (x3)
M6 - Ø 0.9/1.0 (x3)
Type B
Ø 0.9-1.0 / 1.2 (x2)

SUPPORT ÉLINGAGE DÉVIDOIR - Wire feeder support - Drahtvorschubhalterung

036277 211.00 €HT

Max 50 kg EN 60974-1

TF-4RN/W ✓
WS-4R ✓
WS-4L ✓
NEOFEED ✓
EXAFEED ✓

MADE IN FRANCE

SUPPORTS TORCHE MIG - MIG torch supports - MIG-Brennerteleskophalterung

MIG Lift Compact
046597 444.00 €HT

adjustable max 1.3 m

MIG Lift Pro
046429 756.00 €HT

adjustable max 2.5 m

OPTION
Universal wire feeder support
046436 73.80 €HT

180°

360°

MADE IN FRANCE	L	rotation	Torches compatibility		Machines compatibility												Wire feeder compatibility			
			classic	fume extraction	MONOGYS / TRIMIG				PROMIG				MAGYS		EXAGON	NEOPULSE		WS-4R/L	Neofeed/EXAFEED	TF4RN/W
MIG LIFT COMPACT	adjustable 1.3 m max	180°	✓	—	✓	—	✓	✓	✓	—	✓	✓	—	—	—	—	—	—	—	—
MIG LIFT PRO	adjustable 2.5 m max	360°	✓	✓	—	—	—	—	—	✓	✓	—	—	—	—	—	—	—	—	—

SPOT WELDING



PORTASPOT 230
230 V • 1 ~
6 300 A 120 daN

delivered with PX1 :
022256 **1 200,00 €HT**

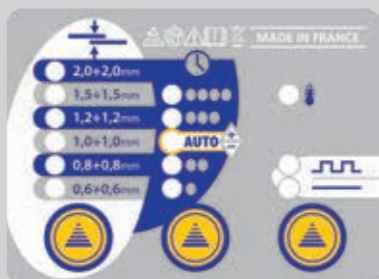

OPTIONS

ARMS Cu Ø23mm

EX60 I = 110 mm PX1 (included) 047945 200,00 €HT	EX40 I = 220 mm PX2 047938 208,00 €HT	EX60 I = 220 mm PX3 047921 205,00 €HT
EX40 I = 350 mm PX4 047914 280,00 €HT	Ref 051614 PX5 048690 225,00 €HT	

ELECTRODES

EX40 Short electrode 40 mm 047884 15,00 €HT
EX60 Medium electrode 60 mm 047891 20,10 €HT
EX80 Long electrode 80 mm 047907 21,00 €HT

CAPS & ACCESSORIES

Caps type F (x 6) 049970 25,00 €HT
Caps remover 050846 62,00 €HT
Lame - Blade 052857 42,00 €HT
Affuteur de caps - Cap grinder 048966 63,00 €HT

50/60 Hz	A	A	A	mm	V	←→	Ø	100% CU	(no arm) cm	kg
1x230V	16(D)	6 300	8900	2+2	2.5	2.5	3x2.5 H05VVf	OK	36 x 29 x 10	10

DRAWN ARC WELDING

MANUAL



7 languages
FR, EN, DE, SP, IT, NL & RU

EXPERT Control



- 1 Amorce - Start-up - Zündung
- 2 Décapage - Scouring (I & t) - Abbeizen
- 3 Arc (I & t) - Arc - Lichtbogen
- 4 Accroche - Hitching (I & t) - Verklebung
- 5 Hauteur - Height - Höhe

SYNERGIC



- Anneaux - Rings - Zugösen
- Goujons - Studs - Gewindebolzen
- Tiges inox - Stainless steel nails - Edelstahlnägel

OPTIONS

20L/min (FR) 041998 38,10 €HT (UK) 040274 (NL) 040267 (IT) 038691	30L/min (FR) 041622 83,00 €HT (UK) 041646 (DE) 041219 (NL) 041615 (IT) 038707	4 m ³ WELD 810 037489 343,00 €HT
---	--	--

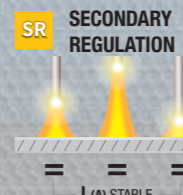
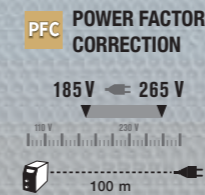

SYNERGIC DIGITAL GUN

★★★★
UNIQUE Linear Motor

DRAWN ARC PROCESS
Gas protection

3 m, Ø 25 mm²
included ARC PULL 200 & 350



Full control



Included x2 059627 **15,00 €HT**

GYSPOT ARC PULL 350

Acier / Steel / Stahl	Alu
350 A	208 → 240 V • 1 ~

PFC SR AD



GAS

GAS NO GAS

MADE IN FRANCE 60974-1	50/60 Hz	6 m	I ₂ A	SYNERGIC	Acier/Steel Alu	TECHNOLOGY Power Factor Correction	U ₂ V	+AM A	kW	OK	OK	cm	ArcPull	ArcPull + gun
GYSPOT ARC PULL 350	208 → 240V	6 m	10 → 350	■	Manual + Digital Gun Motion Control	■	20.4 → 34 V	16	11.9	OK	OK	30 x 24.5 x 22	11 kg	14.3 kg



GYSPOT ARC PULL

DRAWN ARC

WELDING

ALU + STEEL



GYSPOT ARC PULL 700 INDUSTRY

380 · 480V · 3~

680 A x1 MANUAL

SR IP 23

062207 5 438,00 €HT

included

Manual synerpic gun
3 m, 50 mm²

Double earth clamp
3 m, 50 mm²
068605 126,00 €HT

Complete stand ceramic
ferrule Standard 700
068322 313,00 €HT

OPTIONS

Weld 910
070967
394,00 €HT



SYNERGIC DIGITAL GUN

★★★★★

**UNIQUE
Linear
Motor**

**DRAWN ARC
PROCESS**

**Ideal
all position**

3 m, Ø 50 mm²
included ARC PULL 700



Adjustable

Full control

MADE IN FRANCE 60974-1			I ₂ A	SYNERGIC		U ₂ V		kW				cm	ArcPull	ArcPull + gun
GYSPOT ARC PULL 700 INDUSTRY	3x 400 V 3x 480 V	5 m	50 · 680	■	Manual + Digital Gun Motion Control	22 · 44 V	20 A (D) 16 A (D)	47,8 kW 45,7 kW	OK	OK	32 x 32,4 x 41	17,4 kg	20,4 kg	

GYSPOT ARC PULL 350 - ACCESSORIES & CONSUMABLES

Joint rings for mandrel
Ø 4/5/6 (x2)
060814 5,00 €HT

Acier/Steel /Stahl

	Ø 2 mm		Ø 4 mm		Ø 5 mm		Ø 6 mm		Ø 7.1 mm		Ø 8 mm								
	059634 28,00 €HT x1	059641 150,00 €HT x1	064065 56,00 €HT x1	041561 7,00 €HT x100	064034 15,00 €HT x100	049000 38,00 €HT x2	059603 13,00 €HT x100	064607 131,00 €HT x100	048157 18,00 €HT x1	049383 17,00 €HT x100	049413 10,00 €HT x100	049420 11,00 €HT x100	048164 18,00 €HT x1	063969 41,00 €HT x100	063990 144,00 €HT x200	064041 21,00 €HT x1	064003 181,00 €HT x200	064058 28,00 €HT x1	063976 81,00 €HT x100
STEEL STUDS BOX 350 059443 281,00 €HT	x1	x1				x1	x100				x1	x100	x100	x100					

Alu

	Ø 4 mm		Ø 5 mm		Ø 6 mm		Ø 7.1 mm		Ø 8 mm				
	059634 28,00 €HT x1	059641 150,00 €HT x1	049000 38,00 €HT x2	059573 12,00 €HT x100	048157 18,00 €HT x1	059580 12,00 €HT x100	048164 18,00 €HT x1	059597 12,00 €HT x100	064010 135,00 €HT x200	064041 21,00 €HT x1	064027 163,00 €HT x200	064058 28,00 €HT x1	063983 28,00 €HT x100
ALU STUDS BOX 350 059436 256,00 €HT	x1	x1	x1	x100	x1	x100	x1	x100					

STUDS HOLDER BOX 350
064591 419,00 €HT

	Ø 2	Ø 4	Ø 5	Ø 6	Ø 7.1	Ø 8	3 m
	059634 28,00 €HT x1	059641 150,00 €HT x1	064065 56,00 €HT x1	049000 38,00 €HT x2	048157 18,00 €HT x1	048164 18,00 €HT x1	064041 21,00 €HT x1
	x1	x1	x1	x1	x1	x1	x1

ARC PULL DIFFICULT ACCESS BOX 350
070813 570,00 €HT

	Ø 3	M4	M5	M6	M8	3 m
	059634 28,00 €HT x1	059641 150,00 €HT x1	070806 70,00 €HT x1	070790 68,00 €HT x1	070752 55,00 €HT x1	070769 55,00 €HT x1
	x1	x1	x1	x1	x1	x1

Difficult access :



GYSPOT ARC PULL 700 - ACCESSORIES & CONSUMABLES

Fourche céramique standard

	Complete stand ceramic ferrule Standard 700 068322 313,00 €HT		Ø 6				Ø 8				Ø 10				Ø 12			
	068582 175,00 €HT	x1	068445 13,00 €HT	x1	x1	x1	x1	068391 35,00 €HT	x1	068407 35,00 €HT	x1	068414 35,00 €HT	x1	068421 35,00 €HT	x1			
	x1	x1	x1	x1	x1	x1	x1	x1	x1	x1	x1	x1	x1	x1				

Fourche céramique griffe

	Complete stand ceramic ferrule Grip 700 068339 388,00 €HT		Ø 6				Ø 8				Ø 10				Ø 12			
	068575 169,00 €HT	x1	068353 38,00 €HT	x1	068360 38,00 €HT	x1	068377 38,00 €HT	x1	068384 38,00 €HT	x1								
	x1	x1	x1	x1	x1	x1	x1	x1	x1									

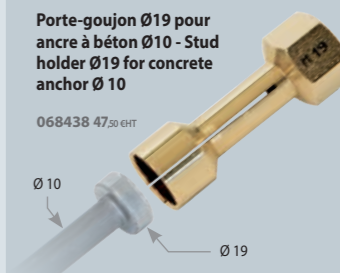

Fourche protection gazeuse

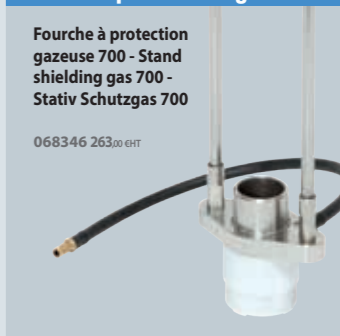

	Arc Pull 700					
	Arc Pull 350	Ø 6	Ø 8	Ø 10	Ø 12	
Ferrules céramique - Ceramic ferrule - Keramikring						
Type UF ISO 13918	068520 52,00 €HT	068537 52,00 €HT	065680 52,00 €HT	065697 52,00 €HT		
	x 500	x 500	x 500	x 500		
Goujons - Studs - Bolzen	M6x20	M8x20	M10x20	M12x50		
Type DD ISO 13918	20-50 mm	Acier - Steel - Stahl	068506 199,00 €HT	068513 239,00 €HT	065659 281,00 €HT	065673 488,00 €HT
		Inox - Stainless steel - Edelstahl	068469 363,00 €HT	068476 494,00 €HT	068483 644,00 €HT	068490 1 200,00 €HT
			x 500	x 500	x 500	x 500
Type SD ISO 13918	100 mm	Ancre à béton - Concrete anchor - Betonanker	—	—	Ø 10 065642 113,00 €HT	—
					x 250	



EASYCUT

PLASMA

1~

COMPRESSOR COMPRESSOR INSIDE

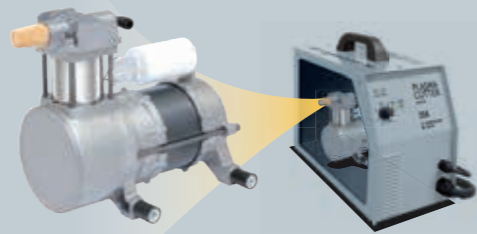

AD ANTI-DUST VENTILATION CORRIDOR

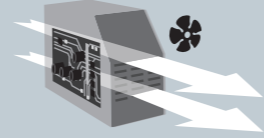

PFC POWER FACTOR CORRECTION

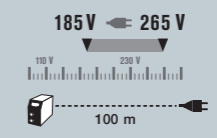

FV FLEXIBLE VOLTAGE

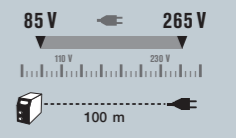

COMING SOON



AIR FILTER

PFC EN 61000-3-12 POWER FACTOR CORRECTION



INCLUDED: 8mm



INCLUDED: 8mm



COMPRESSOR Compressor inside



DIGITAL (PRESSURE SENSOR)

New design, new name CUTTER 30 FV > EASYCUT 30 FV



PFC EN 61000-3-12 FV FLEXIBLE VOLTAGE

DIGITAL (PRESSURE SENSOR)



EASYCUT K25

230 V • 1 ~
25 A Fe 8 mm
Al/CrNi 6 mm

P400 COMPRESSOR

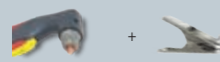

TPT 25, 4 m 068087 2 m, 10 mm²

068063 1 144,00 €HT

EASYCUT K35F

230 V • 1 ~
35 A Fe 15 mm
Al/CrNi 10 mm

P400 PFC AD COMPRESSOR

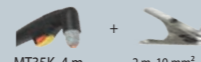

MT35K, 4 m 2 m, 10 mm²

031036 1 606,00 €HT

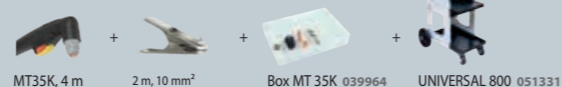

MT35K, 4 m 2 m, 10 mm² Box MT 35K 039964 UNIVERSAL 800 051331
029804 1 985,00 €HT

EASYCUT 25

230 V • 1 ~
25 A Fe 8 mm
Al/CrNi 6 mm

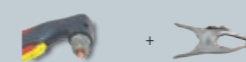

TPT 25, 4 m 068087 2 m, 10 mm²

065543 850,00 €HT

CUTTER 30 FV

110 → 230 V • 1 ~
30 A Fe 15 mm
Al/CrNi 10 mm

P400 PFC FV

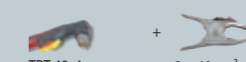

TPT 40, 4 m 060753 2 m, 10 mm²

013858 1 161,00 €HT

EASYCUT 40

230 V • 1 ~
40 A Fe 18 mm
Al/CrNi 15 mm

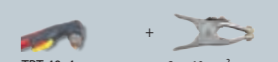

TPT 40, 4 m 060753 2 m, 10 mm²

029743 1 031,00 €HT



OPTIONS



Torches

	I (60%)	I (100%)	L	Consumables	
TPT 25	068087 184,00 €HT	25 A (30%)	15 A	4 m	Included
TPT 40	060753 194,00 €HT	40 A	32 A	4 m	Included

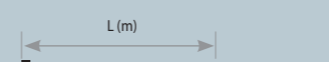

Consumables - Consumables

	x2	x10	x10	x4	
MT 25K			040151 28,00 €HT		Box MT 25K 039971 46,00 €HT
TPT 25	x1 040175 16,00 €HT			040182 44,00 €HT	Box TPT 25 070721 46,00 €HT
MT 35K			040212 28,00 €HT		Box MT 35K 039964 46,00 €HT
TPT 40	x1 040175 16,00 €HT	x3 040168 27,00 €HT		040229 44,00 €HT	Box TPT 40 039957 46,00 €HT

CE NORM EN60974-1	MADE IN FRANCE / MADE IN GYS CHINA	EASYCUT MODEL	Voltage	I ₂	mm				INTEGRATED TECHNOLOGY					AIR SYSTEM			EN 60974-1 (40°C)			kg	Protected & compatible power generator (+/-15%)						
					Coupe max Severance cut	Coupe propre Clean cut	P400	PFC	FV	AD	IP21S	COMPRESSOR	min	ideal	max	I 60%	X% I2max	100%									
★	FR	EASYCUT K25	230V 1~	16	10+25	8	6	6	4	■	■	■	■	■	■	■	included	15 A	35%	—	10/25 mm ² 09 mm	41 x 20 x 36	15	6.5 kW	7.5 kVA		
★	FR	EASYCUT K35F	230V 1~	16	10+35	15	10	10	8	■	■	■	■	■	■	■	included	28 A	30%	20 A	10/25 mm ² 09 mm	52 x 28 x 46	30	8 kW	10 kVA		
★	FR	EASYCUT 25	230V 1~	16	10+25	8	6	6	4	■	■	■	■	■	■	■	2.5 bar	4.5 bar 115 L/min	6.5 bar	15 A	30%	10 A	10/25 mm ² 09 mm	15 x 42 x 30	8	—	—
★	FR	CUTTER 30 FV EASYCUT 30 FV	230V 1~ / 110V 1~	16 / 32	10+30 / 10+30	15 / 10	10 / 10	8 / 8	■	■	■	■	■	■	■	■	2.5 bar	5 bar 115 L/min	9 bar	23 A / 19 A	30% / 25%	20 A / 15 A	10/25 mm ² 09 mm	45 x 28 x 20	10.8	6.5 kW	7.5 kVA
★	FR	EASYCUT 40	230V 1~	32	10+40	20	15	15	10	■	■	■	■	■	■	■	2.5 bar	4.5 bar 115 L/min	6.5 bar	10 A	20%	—	10/25 mm ² 09 mm	15 x 42 x 30	8	—	—

EASYCUT

PLASMA CUTTING • 1 ~

75



74

PLASMA

1 & 3~



DIGITAL PRESSURE SENSOR



DIGITAL PRESSURE SENSOR



CNC COMPUTER NUMERICAL CONTROL

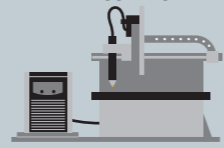

SYNERGIC AIR Pressure

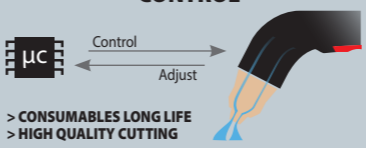

> CONSUMABLES LONG LIFE
> HIGH QUALITY CUTTING

6 modes :

- Coupage / Cutting / Vollblech
- Coupage verrouillé / Locked cutting / Verriegelter Vollblech-Modus
- Gougeage / Gouging / Fugenhobeln
- Gougeage verrouillé / Locked gouging
- Grillage / Metal Mesh / Gitter
- Marquage / Marking



SYNERGIC AIR Pressure



SYNERGIC AIR Pressure



110 · 230 V · 1 ~

CUTTER 45 CT

110 → 230 V · 1 ~

45 A Fe 30 mm
Al/CrNi 20 mm

P400 PFC FV GRID CUT AD IP 23

Option **CNC ANALOGIC**

2 m, 10 mm² TPT 40, 4 m 2 m, 10 mm²
014787 1 563,00 €HT 013629 1 744,00 €HT

MT 70, 6 m 2 m, 10 mm² Box 20-50A 061613
062962 2 140,00 €HT

400 V · 3 ~

CUTTER 70 CT

400 V · 3 ~

70 A Fe 35 mm
Al/CrNi 25 mm

GRID CUT AD IP 23 GOUGING

Option **CNC ANALOGIC**

4 m, 10 mm²
013636 2 344,00 €HT

MT 70, 6 m 4 m, 10 mm² + Starter Kit 70A
013841 2 895,00 €HT

NEOCUT 105

400 V · 3 ~

105 A Fe 50 mm
Al/CrNi 40 mm

GRID CUT Synergic AIR Pressure AD IP 23

MARKING GOUGING

Options **CNC ANALOGIC** **CNC DIGITAL** **CNC RETROFIT DIGITAL**

4 m, 16 mm²
063044

MT 125, 6 m 4 m, 16 mm² + Starter Kit
063112

NEOCUT 125

400 V · 3 ~

125 A Fe 57 mm
Al/CrNi 55 mm

GRID CUT Synergic AIR Pressure AD IP 23

MARKING GOUGING

Options **CNC ANALOGIC** **CNC DIGITAL** **CNC RETROFIT DIGITAL**

4 m, 25 mm²
067431

MT 125, 6 m 4 m, 25 mm² + Starter Kit
067448

Performances with torches "MT-AT"

mm	mm													60 mm	Piercing - Perçage	Clean Cut Coupe Propre	Max Cut (Severance) Coupe Max (Séparation)	
	0.5	2	6	10	15	18	20	25	30	40	50	55						
45 A	Al/CrNi	■	■	■	■	■	■	■	■	■	■	■	■	■	■	■	■	■
	Fe	■	■	■	■	■	■	■	■	■	■	■	■	■	■	■	■	■
70 A	Al/CrNi	■	■	■	■	■	■	■	■	■	■	■	■	■	■	■	■	■
	Fe	■	■	■	■	■	■	■	■	■	■	■	■	■	■	■	■	■
85 A	Al/CrNi	■	■	■	■	■	■	■	■	■	■	■	■	■	■	■	■	■
	Fe	■	■	■	■	■	■	■	■	■	■	■	■	■	■	■	■	■
105 A	Al/CrNi	■	■	■	■	■	■	■	■	■	■	■	■	■	■	■	■	■
	Fe	■	■	■	■	■	■	■	■	■	■	■	■	■	■	■	■	■
125 A	Al/CrNi	■	■	■	■	■	■	■	■	■	■	■	■	■	■	■	■	■
	Fe	■	■	■	■	■	■	■	■	■	■	■	■	■	■	■	■	■

Model	Voltage	I ₂	mm						INTEGRATED TECHNOLOGY				AIR SYSTEM Pressure (bar)			EN 60974-1 (40°C)		Ø	cm	kg	Protected & compatible power generator (+/-15%)						
			Coupe max Severance cut	Coupe propre Clean cut	Perçage Piercing	Grid Cut	Marking	Gouging	Pressure Control	AD	IP23	CNC	min	max	ideal	100%	IA 60%					X% I ₂ max					
CUTTER 45 CT	230V 1~	16	15 → 45	20	15	10	8	6	■	■	■	Digital	■	■	analogic	5	7	5.2 bar (115 L/min)	32 A	41 A	50%	10/25 mm ² Ø 9 mm	48 x 37 x 23	15	10.5 kW	12.5 kVA	
			15 → 30	15	10	8	—	—											—	—	—						—
CUTTER 70 CT	230V 1~	32	15 → 45	30	20	15	10	8	■	■	■	Digital	■	■	analogic	5	9	5.2 bar (185 L/min)	32 A	41 A	50%	10/25 mm ² Ø 9 mm	52 x 40 x 26	22	15 kW		
			15 → 30	15	10	8	—	—											—	—	—						—
NEOCUT 105	400V 3~	32	20 → 105	50	40	35	30	20	18	■	■	■	Synergic	■	■	analogic & digital	5	9	5.5 (305 L/min)	105 A	—	100	10/25 mm ² Ø 9 mm	58 x 52 x 30	33	30 kW	36 kVA
NEOCUT 125	400V 3~	50	20 → 125	57	55	40	40	25	25	■	■	■	Synergic	■	■	analogic & digital	5	9	5.5 (305 L/min)	125 A	—	100	35/70 mm ² Ø 13 mm	58 x 52 x 30	35	30 kW	36 kVA

MANUAL - Hand-held torches

MT torches	(60%)	(100%)	L (m)	ref
MT-70	70 A (50%)	50 A	6	037502 460.00 € HT
			12	037519 628.00 € HT
MT-125	125 A	105 A	6	039506 480.00 € HT
			12	039513 671.00 € HT

EASYFIT ①+②

Easyfit cables	L (m)	ref
MT-70	6	074668
MT-125	12	074675

Easyfit long torches	(60%)	(100%)	Angle	Body (cm)	ref
② MT-125	125 A	105 A	90°	80	074620
			15°	80	074637
			90°	130	074644
			15°	130	074651

Easyfit torches	(60%)	(100%)	Angle	ref
② MT-70	70 A (50%)	50 A	75°	074583
			15°	074590
② MT-125	125 A	105 A	75°	074606
			15°	074613

STANDARD Consumables

Consumables Cutting - Coupage	Diffuseur - Diffuser - Swirl Ring	Electrode - Schneidelektrode	Tuyère - Tip - Düse	Buse - Nozzle - Schneidösenhalter	Patin - Shield	
MT-70	20-50 A	x1 037557 29.50 € HT	x3 037564 24.50 € HT	x3 037571 18.50 € HT Longue - Long 067196 34.50 € HT	x1 037601 38.50 € HT	
	70 A	x1 037557 29.50 € HT	x3 037564 24.50 € HT Longue - Long 067189 38.50 € HT	x3 037588 18.50 € HT Longue - Long 067202 34.50 € HT	x1 037601 38.50 € HT	
MT-125	45 A Precision cut					
	45 A					
	65 A	x1 039131 31.00 € HT	x3 039155 28.00 € HT	x3 039162 21.00 € HT x3 039179 21.00 € HT	x1 039216 54.10 € HT	x1 039230 19.50 € HT
	85 A	x1 039148 32.00 € HT	x3 039155 28.00 € HT	x3 039186 21.00 € HT x3 039193 23.00 € HT	x1 039223 54.10 € HT	x1 039247 20.00 € HT
	105 A	x1 039148 32.00 € HT	x3 039155 28.00 € HT	x3 039193 23.00 € HT x3 039209 23.00 € HT	x1 039223 54.10 € HT	x1 039247 20.00 € HT

Consumables Gouging - Gougeage	Diffuseur - Diffuser - Swirl Ring	Electrode - Schneidelektrode	Tuyère - Tip - Düse	Buse - Nozzle - Schneidösenhalter	Patin - Shield	
MT-70	70 A	037557 29.50 € HT	037564 24.50 € HT	037595 35.50 € HT	037601 38.50 € HT	037632 17.00 € HT
MT-125	65-85 A	039131 31.00 € HT	039155 28.00 € HT	039261 47.00 € HT	039216 54.10 € HT	039254 18.50 € HT
	105 A	039148 32.00 € HT		039278 47.00 € HT	039223 54.10 € HT	

Boxes - Coffrets	MT-70	20-70 A	BOX 20-50 A	BOX 20-70 A	MT-125	45-125 A	BOX 45/65/85 A	BOX 85/105 A	BOX 105/125 A
			061613 118.00 € HT	037540 134.00 € HT			039537 163.00 € HT	064720 253.00 € HT	039544 155.00 € HT

DIFFICULT ACCESS Consumables

Consumables Cutting - Coupage	Diffuseur - Diffuser - Swirl Ring	Electrode - Schneidelektrode	Buse - Nozzle - Schneidösenhalter	Bague - Ring	Tuyère - Tip - Düse	Patin - Shield
MT-70	20-45 A 70 A	037557 29.50 € HT	074682	074859	074897	074767 074774 074910
MT-125	20-45 A 70 A	039131 31.00 € HT	074699	074866	074897	074767 074774 074910
	100 A	039148 32.00 € HT				074781

Consumables Gouging - Gougeage	Diffuseur - Diffuser - Swirl Ring	Electrode - Schneidelektrode	Buse - Nozzle - Schneidösenhalter	Bague - Ring	Tuyère - Tip - Düse	Patin - Shield
MT-70	70 A	037557 29.50 € HT	074682	074859	074897	074798 074927
MT-125	70 A	039131 31.00 € HT	074699	074866	074897	074798 074927
	100 A	039148 32.00 € HT				074804

Extractor - Extracteur 074842
Assembly & disassembly tool
- Outil d'aide à l'installation et au démontage

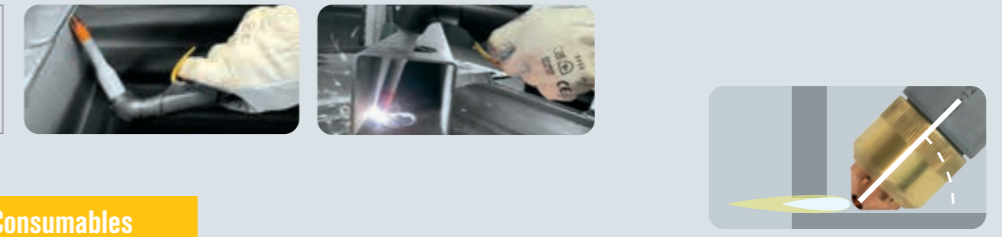

FLAT CUTTING Consumables

Consumables Cutting - Coupage	Diffuseur - Diffuser - Swirl Ring	Electrode - Schneidelektrode	Buse - Nozzle - Schneidösenhalter	Tuyère - Tip - Düse	Bague de maintien - Retaining ring
MT-70	40-70 A	074736	074705	074873	074811
MT-125	40-70 A	074743	074712	074880	074828
	80-125 A	074750	039155 28.00 € HT		074835

AUTOMATIC - Mechanized torches

AT torches	(60%)	(100%)	L (m)	Body (mm)	ref
AT-70	70 A (50%)	50 A	6	"Mini" 127	071865 594.00 € HT
			6	240	037526 611.00 € HT
			12	240	037533 771.00 € HT
AT-125	125 A	105 A	6	240	038479 556.00 € HT
			12	240	039520 746.00 € HT
			15	240	069787 861.00 € HT
			20	240	069794 1 106.00 € HT
AT-160	160 A	125 A	6	240	067479 1 065.00 € HT
			12	240	067486 1 288.00 € HT
			15	240	069800 1 416.00 € HT

Consumables Cutting - Coupage	Diffuseur - Diffuser - Swirl Ring	Electrode - Schneidelektrode	Tuyère - Tip - Düse	Buse - Nozzle - Schneidösenhalter	Buse ohmique - Ohmic nozzle	Déflecteur - Deflector
AT-70	20-50 A 70 A	037557 29.50 € HT	037564 24.50 € HT	037601 38.50 € HT	037618 57.40 € HT	037649 18.50 € HT
						037588 18.50 € HT
AT-125	45 A Precision cut	039131 31.00 € HT	039155 28.00 € HT	039216 54.10 € HT	039339 73.00 € HT	039292 18.50 € HT
	45 A					039162 21.00 € HT
	65 A					039179 21.00 € HT
	85 A					039186 21.00 € HT
	105 A					039193 23.00 € HT
125 A	039209 23.00 € HT	039223 54.10 € HT	039445 73.00 € HT	039308 18.50 € HT		
AT-160	45 A Precision cut	067509 51.30 € HT	067493 42.00 € HT	-	067578 105.00 € HT	067592 28.10 € HT
	45 A					067523 29.40 € HT
	65 A					067530 29.40 € HT
	85 A					067547 29.40 € HT
	105/125 A					067554 33.10 € HT



INDUCTION HEATING

1~

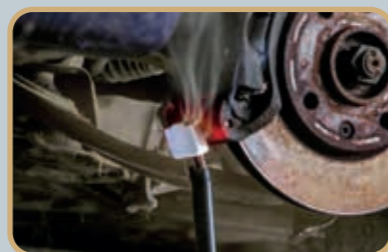

PFC POWER FACTOR CORRECTION

185 V ← 265 V



INCLUDED

Spirale - Coil - Spiralförmiger draht

Ø 18 mm 054806 41,30 € HT

Ø 24 mm 054790 42,50 € HT

Ø 30 mm 055469 42,50 € HT

Fil tressé enroulable - Flexible wrappable wire - Flexibel geflochtener draht

800 mm 054813 78,00 € HT

Fil droit rigide - Straight rigid wire - Steif gerade draht

800 mm 054868 47,50 € HT



1 m

POWERDUCTION 10R

1 200 W 230V • 1~

AIR

062504 894,00 € HT

068643



2 m

POWERDUCTION 37LG

3 700 W 230V • 1~

LIQUID

056992 2 975,00 € HT

072510



3 m

POWERDUCTION 39LG

3 700 W 230V • 1~

PFC LIQUID

058583 3 813,00 € HT



3 m

POWERDUCTION 50LG

5 200 W 230V • 1~

PFC LIQUID

055599 4 175,00 € HT



INDUCTION HEATING

3~



4 m

POWERDUCTION 110LG

11 000 W 400V • 3~

LIQUID

058590 5 994,00 € HT

POWERDUCTION 110LG 208-240V

11 000 W 208-240V • 3~

LIQUID

065246

OPTION 10R

Stripping - Décollage - Entkleben 066601 106,00 € HT



OPTION 37LG

Cable support 052284 106,00 € HT



Chariot - Trolley UNIVERSAL 800 051331 333,00 € HT



Youtube

MADE IN FRANCE	Cable	+AM+	A	W	Freq. kHz	INTEGRATED TECHNOLOGY P400 PFC	Liquid Cooling	Cable L (m)		Heating			cm	kg	Protected & compatible power generator (+/-15%)
								Inductor	Inductor	Heating	Heating	Heating			
POWERDUCTION 10R	230V, 1~	10 mini	1 200	45	80	—	—	2	1	M10 → 1 s	2 mm → 5 s	Ø8 → 10 s	23 x 14 x 10	3	1.5 kW
POWERDUCTION 37LG	230V, 1~	16 mini	3 700	15	30	—	1.51	2	2	M10 → 1 s	2 mm → 5 s	Ø10 → 15 s	45 x 29 x 25	15	4 kW
POWERDUCTION 39LG	230V, 1~	16 mini	3 700	20	60	■	71	2	3	M12 → 1 s	2 mm → 5 s	Ø10 → 15 s	53 x 70 x 37	39.5	4 kW
POWERDUCTION 50LG	230V, 1~	25 mini	5 200	20	60	■	71	8	3	M14 → 1 s	2 mm → 3 s 4 mm → 5 s	Ø10 → 10 s	59 x 88 x 59	70	6 kW
POWERDUCTION 110LG 400V	400V, 3~	16 mini	11 000	20	60	—	71	5	4	M18 → 1 s	2 mm → 2 s 4 mm → 4 s	Ø10 → 7 s	59 x 88 x 59	80	15 kW
POWERDUCTION 110LG 208-240V	208-240V, 3~	35 mini	11 000	20	60	—	71	5	4	M18 → 1 s	2 mm → 2 s 4 mm → 4 s	Ø10 → 7 s	59 x 88 x 59	86	15 kW



INDUCTION HEATING 3~



included adapter 32L + L90 064515 + 059788

6 m

included adapter 32L + L20/B4 064515 + 067882

6 m or 10 m

included removable handle 068599

included removable handle 068599

POWERDUCTION 160LG

16 000 W 400 V • 3~

* LIQUID

057814 7 925,00 €HT

POWERDUCTION 160LG 208-240 V

16 000 W 208-240 V • 3~

* LIQUID

065253

POWERDUCTION 220LG

22 000 W 400 V • 3~

* LIQUID

066861 8 688,00 €HT

POWERDUCTION 220LG 10M

074576

MADE IN FRANCE	Cable L (m)	Freq.	Liquid Cooling	Inductor	Heating		cm	kg	Protected & compatible power generator (+/-15%)			
					Power (W)	Current (A)						
POWERDUCTION 160LG 400V	32 mini	16 000	20+60	301	4	6	M20 → 1s	2 mm → 2s 4 mm → 4s	Ø10 → 5s	70 x 118 x 60	136	22 kW
POWERDUCTION 160LG 208-240V	45 mini	16 000	20+60	301	4	6	M20 → 1s	2 mm → 2s 4 mm → 4s	Ø10 → 5s	70 x 118 x 60	146	22 kW
POWERDUCTION 220LG	32 mini	22 000	20+60	301	4	6	M45 → 3s	4 mm → 3s 8 mm → 9s	Ø10 → 4s	70 x 118 x 60	141	22 kW
POWERDUCTION 220LG 10M	10											

OPTIONS



Housse de protection - Protection cover - Schutzhaube for POWERDUCTION 220 - 160 LG 050853 211,00 €HT



Cooling liquid Included with 160LG & 220 LG 5L 062511 68,00 €HT 10L 052246 138,00 €HT

t° POWER HEAT CONTROLLER

t° CONTROL 80>350°C (210>660°F)



5,5m

POWER HEAT CONTROLLER 061644 400,00 €HT

Included T° sensors thermocouple type K x2



Youtube

OPTIONS



Pyrometer IR for inductor L90

1.1 m 064119 569,00 €HT



INDUCTEURS - Inductors

SMALL (Ø16)

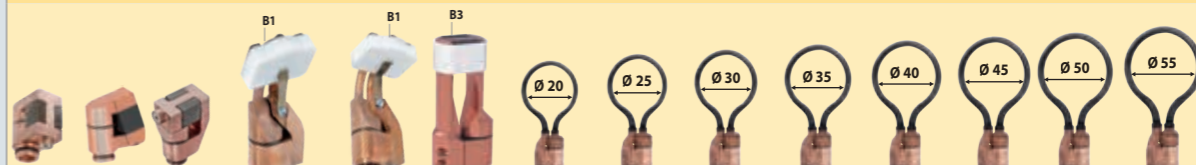

* = original equipment

S90	S70	S180	S20/B1 (20°)	S180/B1	S180/B3W	S180/D20	S180/D25	S180/D30	S180/D35	S180/D40	S180/D45	S180/D50	S180/D55
058927 175,00 €HT	061569 194,00 €HT	059269 231,00 €HT	064874 306,00 €HT	064881 306,00 €HT	067899 281,00 €HT	069985 369,00 €HT	069992 369,00 €HT	070592 369,00 €HT	070608 369,00 €HT	070615 369,00 €HT	070622 369,00 €HT	070639 369,00 €HT	070646 369,00 €HT

37 LG	✓*	✓	✓	✓	✓	✓	✓	✓	✓	✓	✓	✓	✓
39 & 50 LG						✓ with adapter 285							
110 & 160 LG						✓ with adapter 325							
220 LG						✓ with adapter 325							

LARGE (Ø32)



* = original equipment

L90 (90°)	L70 (70°)	L180	L180/Spiral	L20/B4	L20 Alu Glove	L180/D60	L180/D70	L180/D80	L180/D90	L180/D100	L180/D110	L180/D120
059788 363,00 €HT	059771 375,00 €HT	059795 450,00 €HT	065000 631,00 €HT	067882 431,00 €HT	069114 444,00 €HT	069923 450,00 €HT	069930 450,00 €HT	069121 406,00 €HT	069947 450,00 €HT	069954 450,00 €HT	069961 450,00 €HT	069978 450,00 €HT

37 LG												
39 & 50 LG		✓ with adapter 28L							✓ with adapter 28L			
110 & 160 LG	✓* with adapter 32L*		✓ with adapter 32L						✓ with adapter 32L			
220 LG		✓ with adapter 32L		✓ with adapter 32L*					✓ with adapter 32L			

ADAPTER

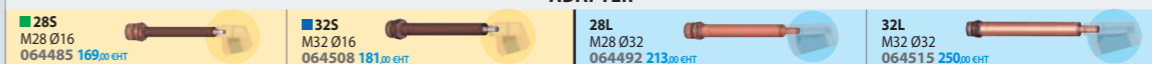

37 LG							
39 & 50 LG	✓					✓	
110 & 160 LG			✓				✓
220 LG			✓				✓

COMPLETE (Ø28)



39 & 50 LG	✓*		✓
------------	----	--	---

BOÎTES - Boxes

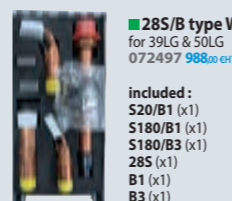

28S/B type W for 39LG & 50LG 072497 988,00 €HT

included: S20/B1 (x1) S180/B1 (x1) S180/B3 (x1) 28S (x1) B1 (x1) B3 (x1)

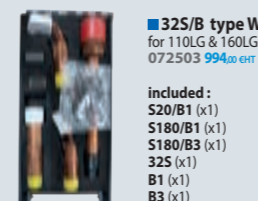

32S/B type W for 110LG & 160LG 072503 994,00 €HT

included: S20/B1 (x1) S180/B1 (x1) S180/B3 (x1) 32S (x1) B1 (x1) B3 (x1)



L box 065796 769,00 €HT

included: L70 (x1) L180 (x1)

FERRITES - Ferrites - Ferritaufsatz



B1 053823 12,00 €HT B2 053458 12,00 €HT B3 067875 12,00 €HT B4 053755 100,00 €HT

B1 056909 31,00 €HT B2 056916 31,00 €HT B3 072527 35,00 €HT B4 054844 47,00 €HT

Glue kit for inductor Kit de colle pour inducteur 075948



Colle-Stick bi-composants Power Epoxy 150°C 054851 50,00 €HT



CALIBRATION SET

FOR MMA - TIG - MIG/MAG



IP67



VALISE D'ÉTALONNAGE - Validation/calibration set - Kalibrierungsset

GCU 1.0
060456

■ **Etablissement de QMOS et suivi des DMOS** -
Creations of WPQR followed by WPS -
Erstellung von WPQR und Nachverfolgung von WPS

■ **Vérification périodique du matériel de soudage** -
Regular welding equipment checks -
Periodische Überprüfung des Schweißgerätes

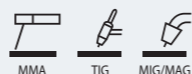

■ **Applications :**



Parameters (precision)				FV	↕	⚙️	IP
U	I	⊗	Gas calibration				
TRMS-Instant-Average				50/60Hz			
1 > 120 V (± 0.5%)	1 > 500 A (± 0.5%)	1 > 30 m/min (± 1%)	1 > 30 L/min (± 5%)	85 > 265 V	21 x 43 x 57 cm	12 kg	IP 67



Discover it on
YouTube



Multimètre - Multimeter - Multimeter

Mesure d'énergie - Energy tracking - Energiemessung

Validation - Calibration - Kalibrierung



EN 1090 EN 50 504 EN 60974-14 SOFTWARE INCLUDED 5 languages (FR/EN/DE/ES/IT)

Included connections

VM1 Voltage measurement cables (2m) 060531 225.00 € HT	PC1 Power cable (2m) 060593 72.50 € HT	GM1 Gas measurement (2m) 060555 50.00 € HT	DRC1 Command cable DIN/DIN (2m) 060579 62.50 € HT	RC1 Remote control DIN (2m) 060562 62.50 € HT
VM2 Voltage measurement cable (2m) 060548 81.30 € HT	USB1 USB 2.0 cable (1.5m) 060609 31.30 € HT	ARC1 Command cable DIN/Amphenol (2m) 060586 62.50 € HT	RC1 + ECM1 ✓ RC1 + DRC1 ✓ RC1 + ARC1 ✓	

OPTIONS

ECM1 060524	Tachymètre vitesse fil - Wire Speed Meter - Geschwindigkeitsmesser 060517
ECM1 + VM1 : Measurement MIG/MAG (U / I / ⊗ / Gas)	

PACK	Complete Calibration	Calibration	Tracking Calibration	060630	060456	connections included	060524	060425	060647 170.00 € HT	—	—	060517

CHARGE D'ÉTALONNAGE - Load bank - Lichtbogen-Last-Simulator

Caliweld LOAD 550A
060425



	550 A @ 3% (MIG)
MMA	5>550 A
TIG	5>550 A
MIG/MAG	5>550 A
X%	3%
↕/⚙️	60 x 27 x 50 cm / 16 kg

Options

MIG EURO CONNECTION

Câble connexion EURO MIG avec commande à distance - Calibration cable with euro torch connector and remote control
316 A @ 60%
054097



CABLE

Rallonge câble, connexions texas (mâle + femelle)

1.3 m	95 mm ²	033689	106.00 € HT
5 m	95 mm ²	032439	254.00 € HT
10 m	95 mm ²	032446	445.00 € HT
20 m	95 mm ²	036673	929.00 € HT



CONTRÔLE DU GÉNÉRATEUR - Generator control - Prüfgeräte



Débitmètre de bout de torche - Torch Gas Flow-Meter - Durchflussmesser
053939 30.00 € HT



Pince ampérométrique - Clamp-on ammeter - Strommesszange
400 A
053991 165.00 € HT
600 A
053984 244.00 € HT

MARQUEURS & CRAIES - Markers & Chalk - Marker & Kreide

Compatibles Soudure - Welding compatible - Lötfähig



Marqueurs blancs industriels - Industrial white markers - Industrielle weiße Marker
069343 30.00 € HT

Support craies plates & Craies plates compatibles soudure - Flat chalk holder & Welding compatible flat chalks - Flache Kreidehalter & Lötkompatible Flachkreiden
Stéatite - Soapstone - Speckstein
069374 27.50 € HT

Marqueur trous profonds - Deep hole marker - Tieflochmarkierer
069350 40.00 € HT

CONTRÔLE DE PIÈCES - Metal control - Werkstückprüfgeräte



Crayon marqueur thermique - Thermal marking pencil - Thermo-Prüfstift
121°C - 250°F
052765 43.00 € HT



Jauge pour cordon de soudage - Welding Gauge - Schweißnahtlehre
053977 81.30 € HT



Calibre d'épaisseur de tôle - Sheet thickness gauge - Blechdickenmessgerät
0,6 > 8 mm
071414 10.00 € HT

Thermomètre infrarouge - Infrared Thermometer - Infrarot Thermometer
-50/+380°C,
-58/+716°F
052994 40.00 € HT



Miroir d'inspection flexible magnétique - Flexible inspection mirror (magnetic) - Flexibler, magnetischer Inspektionsspiegel
400 mm
060623 15.00 € HT



TROLLEYS

CHARIOTS - FAHRWAGEN - CARROS



SKATES



1 Skate WS-4R/-4L/Easycut K35F
 ↳ 14 x 46 x 59 cm / 7,9 kg
 ↳ 10 x 71 x 25 cm / 8,3 kg
 0409777 170.00 € HT



2 Skate Titan 400
 NEOPULSE 320C (+WCU)/
 NEOCUT 105 / NEOCUT 125
 ↳ 115 x 53 x 76 cm / 7,8 kg
 ↳ 10 x 35 x 70 cm / 8,3 kg
 037717 199.00 € HT



3 Skate Titanium 400
 NEOPULSE 320C (+WCU)/
 NEOCUT 105 / NEOCUT 125
 ↳ 10 x 35 x 70 cm / 8 kg
 073593 126.00 € HT



4 Skate TIG 250 AC/DC
 ↳ 80 x 47 x 90 cm / 8 kg
 ↳ 12 x 37 x 58 cm / 8,8 kg
 040960 189.00 € HT

CHARIOT PALETTE - Pallet trolley



PLASMA



4M³



8 WELD 610
 ↳ 62 x 43 x 77 cm / 9,5 kg
 ↳ 12 x 80 x 30 cm / 10,5 kg
 040281 211.00 € HT



9 WELD 810
 ↳ 139 x 50 x 77 cm / 20,1 kg
 ↳ 14 x 80 x 51 cm / 21,6 kg
 037489 343.00 € HT

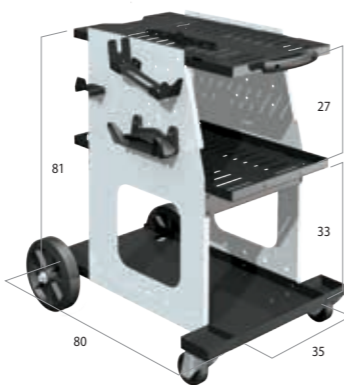

10 WELD 910
 ↳ 84 x 52 x 89 cm / 25 kg
 ↳ 22 x 80 x 52 cm / 27 kg
 070967 394.00 € HT



11 4M³L
 ↳ 90 x 51 x 99 cm / 15 kg
 ↳ 23 x 37 x 99 cm / 16,6 kg
 071568 343.00 € HT

DIABLES - Sack truck - Fahrwagen mit Rädern

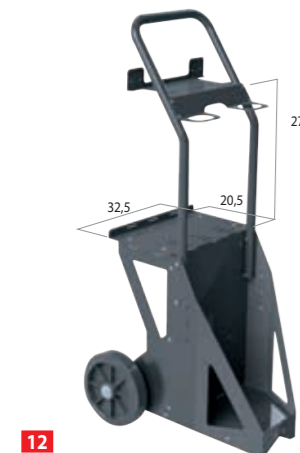

12 Diabale 4m³
 ↳ 106 x 46 x 50 cm / 15,7 kg
 ↳ 36 x 43 x 73 cm / 16,4 kg
 015678 284.00 € HT



13 Diabale 10m³
 ↳ 117 x 53 x 55 cm / 22 kg
 ↳ 29 x 80 x 53 cm / 22,5 kg
 039704 436.00 € HT



14 Diabale 10m³ New Design
 ↳ 118 x 61 x 61 cm / 19 kg
 ↳ 29 x 80 x 53 cm / 19,5 kg
 076341



15 Diabale JOBSITE XL
 ↳ 118 x 61 x 60 cm / 18,3 kg
 ↳ 20 x 47 x 66 cm / 19,5 kg
 039568 423.00 € HT

10M³

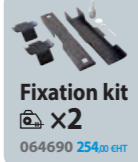

OX & AD



TROLLEYS COMPATIBILITY

TIG	2	3	4	5	8	9	10	11	12	13	14	15	16	17	18
TIG 160 DC lift						✓	✓		✓	✓					
TIG 161 DC						✓	✓		✓	✓					
PROTIG 200 DC									✓	✓	✓	✓	✓	✓	✓
PROTIG 201 DC FV						✓	✓		✓	✓	✓	✓	✓	✓	✓
PROTIG 220 DC FV									✓	✓	✓	✓	✓	✓	✓
PROTIG 221 DC FV						✓	✓		✓	✓	✓	✓	✓	✓	✓
TIG 300 DC									✓	✓	✓	✓	✓	✓	✓
TITAN 400 DC	✓														✓
PROTIG 200 AC/DC						✓	✓		✓	✓	✓	✓	✓	✓	✓
PROTIG 201 AC/DC - L AC/DC						✓	✓		✓	✓	✓	✓	✓	✓	✓
TIG 220 AC/DC									✓	✓	✓	✓	✓	✓	✓
TIG 250 AC/DC						✓									
TITANIUM 230 AC/DC										✓					
TITANIUM 400 AC/DC	✓					✓							✓		✓

PLASMA	1	2	3	6	7	15
EASYCUT K25			✓	✓	✓	
EASYCUT K35F	✓			✓	✓	
EASYCUT 30 FV				✓	✓	
EASYCUT 40				✓	✓	
CUTTER 45CT					✓	
CUTTER 70CT					✓	
NEOCUT 105	✓	✓			✓	
NEOCUT 125	✓	✓			✓	

MIG	1	2	3	5	8	9	10	11	15	16	18
MultiPEARL 210-2						✓	✓	✓	✓	✓	✓
MultiPEARL 210-4 XL						✓	✓	✓	✓	✓	✓
MULTIWELD T-C								✓	✓	✓	✓
WS-4R / WS-4L				✓							
EXAGON 400					✓						✓
NEOPULSE 220 C									✓	✓	✓
NEOPULSE 220 C XL									✓	✓	✓
NEOPULSE 320 C				+	+	+			✓	✓	✓
NEOPULSE 400 G					✓						✓
NEOPULSE 500 G					✓						✓

MMA	5	15	16	17
400 TRI		✓		
PROGYS FLEX 280 CEL		✓	✓	
GENIUS 400	✓	✓		✓

INDUCTION

7

POWERDUCTION 37LG ✓

TIG / MIG LIQUID

COOLING UNITS

GROUPES FROIDS - KÜHLAGGREGATE - GRUPOS DE REFRIGERACIÓN

GROUPES UNIVERSELS - Universal watercooling units - Kühlaggregat



MULTICOOL 500
 ↳ 47 x 24 x 16 cm
 069206 613.00 € HT



MULTICOOL 1300
 ↳ 70 x 28 x 39 cm
 036628 819.00 € HT



COOLING UNITS COMPATIBILITY

	50/60 Hz	W	ON/OFF	COMMAND	kg	COMPATIBILITY
UNIVERSAL	MULTI COOL 500	230V 1~	500	1.5L	8	all TIG 1~, all MIG 1~
	MULTI COOL 1300	230V 1~	1300	7L	19	all TIG 1~, all MIG 1~
DEDICATED	WCU 0.5kW A	230V 1~	500	1.5L	8	TIG 220 DC
	WCU 1kW A	230V 1~	1000	3L	14	TIG 220 AC DC
	KOOL 1.24 TIG	24V DC	800	5.5L	15	TITANIUM 230
DEDICATED	WCU 1kW B	400V 3~	1000	3L	15	TIG 300 DC
	WCU 1kW C	400V 3~	1000	5.5L	17	TITAN 400 DC, TITANIUM 400 AC DC, NEOPULSE 320C
DEDICATED	GENCOOL	400V 3~	1000	5.5L	20	EXAGON
	PULSCOOL / TWINCOOL	400V 3~	1000	5.5L	20	NEOPULSE 400G / 500G

GROUPES DÉDIÉS - Dedicated cooling units - Kühlaggregat



Welding Cable - Schweißkabel

EN 60245-6
H01N2-D
(Caoutchouc - Rubber)



High Flexibility Electrical Cable

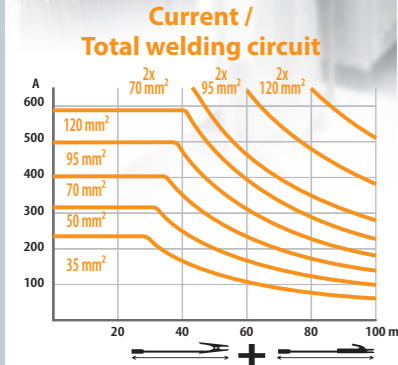

		EN 60974-9		
⊗	↔ L	Ref.	A (60%)	A (35%)
16 mm ²	↔ x m	046207 8 ₀₀ €HT	121	131
	100 m	046252		
25 mm ²	↔ x m	046306 13 ₃₀ €HT	165	185
	5 m	045408 57 ₀₀ €HT		
	100 m	046603		
35 mm ²	↔ x m	046405 16 ₀₀ €HT	211	243
	100 m	046702		
50 mm ²	↔ x m	046757 22 ₄₀ €HT	275	323
	100 m	046801		
70 mm ²	↔ x m	046832 32 ₀₀ €HT	351	419
	500 m	036680		
95 mm ²	↔ x m	046863 43 ₃₀ €HT	433	527
	300 m	036697		

⊗	↔ L			A (60%)	A (35%)
10 mm ²	100 m	054882	054875	88	92
	20 m	056107 86 ₃₀ €HT	056091 86 ₃₀ €HT		
16 mm ²	100 m	054905	054899	120	130
	20 m	056121 118 ₀₀ €HT	056114 118 ₀₀ €HT		
25 mm ²	100 m	054929	054912	164	184
	20 m	056145 181 ₀₀ €HT	056138 181 ₀₀ €HT		
35 mm ²	100 m	054943	054936	210	240
	20 m	056169 244 ₀₀ €HT	056152 244 ₀₀ €HT		
50 mm ²	100 m	054967	054950	273	320
	20 m	056183 344 ₀₀ €HT	056176 344 ₀₀ €HT		
70 mm ²	50 m	—	056565	310	380

COSSES - Cable lugs - Kabelschuhe - Terminal - Kabelschuhe - Terminal

⊗ max	∅	Ref.
10 mm ²	M5	x100 047501 16 ₀₀ €HT
	M5	x100 047518 21 ₀₀ €HT
25 mm ²	M5	x100 047525 48 ₀₀ €HT
	M6	x100 047532 59 ₀₀ €HT
35 mm ²	M6	x100 047532 59 ₀₀ €HT
	M10	x100 047549 90 ₀₀ €HT
70 mm ²	M10	x100 047556 231 ₀₀ €HT
	M10	x50 047570 224 ₀₀ €HT
95 mm ²	M10	x10 038219 32 ₀₀ €HT
	M10	x10 038226 35 ₀₀ €HT
35 mm ²	M14	x10 038233 44 ₀₀ €HT
	M14	x10 038240 57 ₀₀ €HT
75 mm ²	M16	x10 038257 86 ₀₀ €HT
	M15	x5 038264 58 ₀₀ €HT

DOUILLES TEXAS - Dinze sockets - Anschlussbuchse

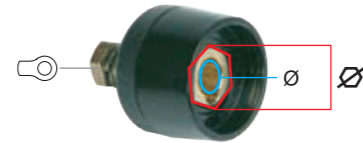

I A max	∅ mm	∅ mm	∅ mm	∅ mm	∅ mm	Compatibility	Ref.
DF 25.14	200	32	10/25	14	9	M8	CM25.14 x20 045644 40 ₀₀ €HT
DF 70.21	400	49	35/70	21	13	M10	CM 50.21, CM 70.21 x10 045637 57 ₀₀ €HT
DF 95.24	500	38	70/95	24	13	M12	CM 95.24 x5 045743 60 ₀₀ €HT

TEXAS MEASURE DE TENSION - Dinze voltage measuring cable - Spannungsmessleitung



ADAPTATEURS TEXAS - Adaptators - Adapter mit Messfunktion

I A max	∅ mm	∅ mm	∅ mm	Compatibility	Ref.		
AMF 25/50	200	32	10/25	14	9	M8	CM25.14 x20 045644 40 ₀₀ €HT
AMF 50/25	400	49	35/70	21	13	M10	CM 50.21, CM 70.21 x10 045637 57 ₀₀ €HT
CFDM 95/95	500	38	70/95	24	13	M12	CM 95.24 x5 045743 60 ₀₀ €HT

CONNECTEURS TEXAS - Dinze connectors - Stecker - Conectores - Schakelears - Conectores

I A max	∅ mm	∅ mm	∅ mm	Compatibility	Ref.	
CFM 25.14	200	10/25	14	9	CM 25.14, DF 25.14, CF 25.14	x1 045507 10 ₀₀ €HT
CFM 50.21	300	35/50	21	13	CM 50.21, CF 50.21, TX 70.21	x1 045606 12 ₀₀ €HT
CFM 70.21	400	50/70	21	13	CM 70.21, TX 70.21	x1 047488 20 ₀₀ €HT
CM 25.14	200	10/25	14	9	DF 25.14, CF 25.14	x20 045668 50 ₀₀ €HT
CM 50.21	300	35/50	21	13	DF 70.21, CF 50.21	x10 045613 59 ₀₀ €HT
CM 70.21	400	50/70	21	13	DF 70.21, CF 70.21	x5 045750 42 ₀₀ €HT
CM 95.24	500	70/95	24	13	DF 95.24	x5 047495 79 ₀₀ €HT
CF 25.14	200	10/25	14	9	CM 25.14	x30 045651 148 ₀₀ €HT
CF 50.21	300	35/50	21	13	CM 50.21	x10 045620 64 ₀₀ €HT
CF 70.24	400	50/70	24	13	CM 70.21	x5 045736 44 ₀₀ €HT
CF 95.24	500	70/95	24	13	CM 95.24	x5 072374 45 ₀₀ €HT



CROCO



	CROCO A200.35	CROCO B250.25	CROCO B300.70	CROCO T300.70	CROCO T400.70	CROCO B600.95 (500A)	CROCO T600.95	CROCO M600.95
A	200 A	250 A	300 A	300 A	400 A	500 A	600 A	600 A
⊗ max	35 mm ²	25 mm ²	70 mm ²	70 mm ²	70 mm ²	95 mm ²	95 mm ²	95 mm ²
A (X%)	200A (35%) 150A (60%)	250 A (35%) 200 A (60%)	300A (35%) 250A (60%)	300A (35%) 250A (60%)	400A (35%) 300A (60%)	500A (35%) 400A (60%)	600A (35%) 400A (60%)	600A (35%) 400A (60%)
x1 (vrac)	043114 5 ₀₀ €HT	038035 10 ₀₀ €HT	043138 14 ₀₀ €HT	037922 8 ₀₀ €HT	043213 8 ₀₀ €HT	038042 23 ₀₀ €HT	046559 17 ₀₀ €HT	038301 15 ₀₀ €HT
*x1 (blister)	043107 5 ₀₀ €HT			037939 9 ₀₀ €HT	043206 9 ₀₀ €HT			
⊗ (x25)	043121 95 ₀₀ €HT		043145 363 ₀₀ €HT	037946 185 ₀₀ €HT	043152 189 ₀₀ €HT			

RHINO & TYREX



	RHINO 300.50 (250A)	TYREX 400.70	TYREX XL 400.70	RHINO 600.95	TYREX 600.95	TYREX + 600.95	TYREX 800.120
A	250 A	400 A	400 A	600 A	600 A	600 A	800 A
⊗ max	50 mm ²	70 mm ²	70 mm ²	95 mm ²	95 mm ²	95 mm ²	120 mm ²
A (X%)	250A (35%) 200A (60%)	400A (35%) 300A (60%)	400A (35%) 300A (60%)	600A (35%) 500A (60%)	600A (35%) 500A (60%)	600A (35%) 500A (60%)	800A (35%) 700A (60%)
x1 (vrac)	038059 22,80 €HT	043176 18,50 €HT	048997 15,10 €HT	038066 36,50 €HT	043220 27,10 €HT	046566 32,90 €HT	046573 96,90 €HT
⊗ (x10)					(x10) 043169 256,00 €HT		

MASSES MAGNÉTIQUES - Earth magnets - Magnetische Masse



A	SQUARE MAGNET 500.70	ROUND MAGNET 500.70	ROUND MAGNET 600.95
A	500 A	500 A	600 A
⊗ max	70 mm ²	70 mm ²	95 mm ²
A (X%)	500A (35%), 400A (60%)	500A (35%), 400A (60%)	600A (35%), 500A (60%)
x1 (vrac)	048980 20,30 €HT	048973 17,40 €HT	047105 104,00 €HT

PINCES DE MASSE ASSEMBLÉES - Earth clamp kits - Vormontierte Masseklemmen

	A	∅	L (m)	⊗ (mm ²)	∅ (mm)	Ref.
Cable H07 for Cutting & Welding	200 A	CROCO T300.70	4	16	10 / 25	9 x1 036932 56 ₀₀ €HT
	250 A	CROCO T300.70	4	25	35 / 50	13 x1 075214
	150 / 200 A	CROCO A200.35	2	16	10 / 25	9 x1 043770 27 ₀₀ €HT
	250 A	CROCO T400.70	3	25	10 / 25	9 x1 043787 48 ₀₀ €HT
Cable H01 for Welding only	250 A	CROCO T400.70	4	25	35 / 50	13 x1 043794 62 ₀₀ €HT
	400 A	CROCO T400.70	4	35	35 / 50	13 x1 043817 78 ₀₀ €HT
	400 A	CROCO T400.70	4	50	35 / 50	13 x1 047853 103 ₀₀ €HT
	600 A	TYREX 600.95	4	70	35 / 50	13 x1 043831 190 ₀₀ €HT
	600 A	CROCO M600.95	4	70	35 / 50	13 x1 036994 181 ₀₀ €HT
	800 A	TYREX+ 800.120	4	95	35 / 50	13 x1 047013 328 ₀₀ €HT

MANOMÈTRES-DÉBITMÈTRES - Pressure-Regulators
- Druckminderer - Regulator de presión
- Manometer stromingsmeter - Regolatore di pressione

	12L/min	15L/min	30L/min (Argon/CO ₂)	OPTIMAPRO 30L/min (Argon/CO ₂)
FR/ES/PT	041820 31,30 €HT	041998 38,10 €HT	041622 83,30 €HT	043619 256,00 €HT
DE	041820 31,30 €HT	041998 38,10 €HT	041219	043633
UK		040274	041646	043626
NL		040267	041615	043640
IT		038691	038707	

Pour cartouche de gaz - For disposable bottle - Für Einweggasflaschen (Argon/CO₂)
041639 31,30 €HT

BOUTEILLES DE GAZ JETABLES
- Disposable bottles - Einweggasflaschen

	composition %		material	L	ref.
	Ar	CO ₂			
AR/CO ₂ 1.8 L	80	20	Acier-Steel-Stahl	1.8 (150L)	043664 39,30 €HT
AR/CO ₂ 2.2 L	80	20	Acier-Steel-Stahl	2.2 (220L)	043671 53,80 €HT
AR pur 2.2 L	100	—	Alu	2.2 (220L)	043688 53,80 €HT

Pressure-flowmeters are country-specific: see datasheets at www.gys.fr

PRÉCHAUFFEUR DE GAZ - Gas preheater - Gasvorwärmer

for CO₂ pur or CO₂/Ar
230 V
power: 25 W
max pressure: 200 bar
IP 44
1.5 kg

Compatible:
20L/min (FR & DE) 041998
30L/min (FR) 041622

(FR & DE) 046511 163,00 €HT

RACCORDS GAZ - Gas connector - Gasanschlüsse

Tuyau caoutchouc - Rubber hose Ø 6.3 X 13 (EN ISO 3821)

1.5 m 066670 11,30 €HT
4 m 046269 24,30 €HT
x m 046276 8,00 €HT

x2 045712 11,00 €HT
x1 046245 5,00 €HT

MARTEAUX À PIQUER - Chipping Hammers - Schlaghammer - Martillos

HAMMER 260
260 mm / 240 g
(x1) 044159 4,30 €HT

HAMMER 285
285 mm / 425 g
(x1) 044128 6,30 €HT

HAMMER 370 PRO
Premium
270 mm / 370 g
(x1) 066663 8,00 €HT

HAMMER 290 PRO
Premium
290 mm / 465 g
(x1) 044135 8,30 €HT

HAMMER 320 PRO
Premium
320 mm / 425 g
(x1) 044142 24,30 €HT

BROSSES - Wire brushes - Bürsten - Broses - Cepillos

	Acier - Steel - Stahl - Acero - Staal - Aço	Inox - Stainless - Edelstahl
A	4 (x1) 044241 2,30 €HT (x24) 044265 49,10 €HT	(x1) 044258 5,30 €HT (x24) 044272 99,10 €HT
B	3 (x1) 044227 2,10 €HT	(x1) 044289 2,70 €HT
C	2 (x1) 044166 3,30 €HT	—
D	(x1) Laiton - Brass 038073 4,30 €HT (x1) Zinc 038080 4,30 €HT	—

POSITIONNEURS MAGNÉTIQUES - Special welding magnet - Imán especial para soldadura - Magnetische Positionierer

	MAGNETIC P15.90	MAGNETIC P16.90	MAGNETIC P19.90	MAGNETIC P20.180	MAGNETIC D30.90	MAGNETIC D50.90 DUAL	MAGNETIC D50.90	MAGNETIC D70.90M	MAGNETIC D70.120M	MAGNETIC D70.135M
Classic					Switchable ON/OFF					
max	15 kg	16 kg	19 kg	20 kg	30 kg	50 kg	50 kg	60 kg	60 kg	60 kg
∠	60/90°	45/90/135°	45/90/135°	articulated 0 > 180°	45/90/135°	90°	90°	90°	45/60/75/90/105/135°	45/75/90/105/135°
x	2	4	1	1	1	1	1	1	1	1
↕	100 x 73 x 12	45 x 32 x 28	156 x 102 x 20	204 x 86 x 28	111 x 95 x 25	148 x 148 x 38	71 x 60 x 48	48 x 32 x 70	111 x 55 x 80	99 x 55 x 80
Ref.	047044 29,40 €HT	044180 9,90 €HT	044203 9,30 €HT	044302 16,10 €HT	044197 33,50 €HT	047051 130,00 €HT	047075 90,60 €HT	047068 81,30 €HT	047082 116,00 €HT	047099 116,00 €HT

PINCES AXIALES - Axial-grip pliers

050242 210,00 €HT

Type I, Type J, Type JJ, Type W, Type LL, Type G

PINCES ÉTAU MONO SERRAGE - Lock-grip pliers

X6 - KIT: 050112 109,00 €HT

KIT: 050266 136,00 €HT

X3, X3, X5, X5 = 16

ASPIRATEURS DE FUMÉE - Fume Extraction Systems - Rauchgasabsauggerät

UNI 2.0 RE

- 400V 3 ~
- 50 Hz
- 1 100 W
- 1 500 m³/h max

- arm 3 m
- no plug
- 100 kg
- extraction 0.5 m/s

061545 5 025,00 €HT

EVO 2.1 RE

- 230V 1 ~
- 50 Hz
- 1 100 W
- 1 200 m³/h max

- arm 3 m
- included
- 85 kg

061552 4 413,00 €HT

EVO 2.2

- 230V 1 ~
- 50 Hz
- 1 100 W
- 1 100 m³/h max

- arm 3 m
- included
- 85 kg

073814

Breveté - Patented

Ø 150 mm

792 mm

347 mm

Ø 150 mm

Included: Pré filtre, treillis Aluminium Class of filtration G3 EN 779 + Filtre - Coal Filter EPA E12 EN 779, Filtration >99.5 %
046467 544,00 €HT

Options: Filtre à charbon actif - Coal filter
064522 288,00 €HT

Extraction flexible 10 m, Ø 152 mm
062139 98,00 €HT

Included: Pré filtre, treillis Aluminium Class of filtration F15 G2 EN 779 + Filtre - Coal Filter HEPA H13 EN 779, Filtration >99.95%
046498 588,00 €HT

Included: Pré filtre, treillis Aluminium Class of filtration F15 G2 EN 779 + Filtre - Coal Filter HEPA H13 EN 779, Filtration >99.95%
075177

TORCHES ASPIRANTES - Fume Extraction Torches - Rauchgas-Absaugbrenner - Antorcha con aspiración de humos

	Acier/Inox - Steel/Stainless steel - Stahl/Edelstahl			
	AIR 150 A	250 A	350 A	LIQUID 500 A
original equipment	M6	M6	M8	M8
X % 40°C - ArCO ₂	150A - 60%	200A - 60%	290A - 60%	380A - 100%
GRIP	GRIP	GRIP	GRIP	GRIP
L	3m	3m	4m	4m
Ref.	043251 634,00 €HT	040540 723,00 €HT	040557 836,00 €HT	040564 980,00 €HT

Pour torches aspirantes - for fume Extraction Torches

included: 5 m, Ø50

230V / 1 ~, 1 100 W
• 200 m³/h max
• 190 mbar max
• 26 kg, 390 x 210 x 500 mm
• 71 db

Système de nettoyage automatique du filtre - Filter auto cleaning system - Automatische Filterabreinigung

Manuel 043244 3 088,00 €HT

included: 5 m, Ø50

230V / 1 ~, 1 100 W
• 230 m³/h max
• 190 mbar max
• 25 kg, 590 x 425 x 825 mm
• 76 db

Système de nettoyage automatique du filtre - Filter auto cleaning system - Automatische Filterabreinigung

Manuel 043244 3 088,00 €HT

included: 5 m, Ø50

230V / 1 ~, 1 100 W
• 230 m³/h max
• 190 mbar max
• 25 kg, 590 x 425 x 825 mm
• 76 db

Système de nettoyage automatique du filtre - Filter auto cleaning system - Automatische Filterabreinigung

Manuel 043244 3 088,00 €HT

included: 5 m, Ø50

230V / 1 ~, 1 100 W
• 230 m³/h max
• 190 mbar max
• 25 kg, 590 x 425 x 825 mm
• 76 db

Système de nettoyage automatique du filtre - Filter auto cleaning system - Automatische Filterabreinigung

Manuel 043244 3 088,00 €HT

MASQUES RESPIRATOIRES - Masks respirators - Atemschutzmasken - Máscaras respiratorias

FFP2D-OV M/L (x5) EN 149 043923 38,00 €HT

FFP1 (x20) EN 149 043916 56,30 €HT

FFP3 - EN 140 / EN 143 (x1) Size M/L 037014 44,00 €HT

Étui / Case 037045 20,30 €HT

FFP3 - EN 143 Anti poussières / Anti odours 037038 19,80 €HT

FFP3 - EN 140 / EN 143 / EN 166 (x1) Size M/L 037021 93,00 €HT

CABINE DE SOUDAGE - Welding booth - Schweißstand



Compact
400 x 400 x 500 mm
060173 **325,00 € HT**

590 x 450 x 1000 mm
060050 **1131,00 € HT**

ÉCRANS DE PROTECTION - Welding curtain and frame - Schweißerschutzwand

ISO 25980 / EN 1598 / AWSF2.3M:2011



MADE IN FRANCE

	OPTI STRIPS (PRE-DRILLED)	OPTI 140.0
cm	30 x 180 (x8)	160 x 140
mm	2	0,4
ref	061514 400,00 € HT	060487 51,30 € HT

BASIC

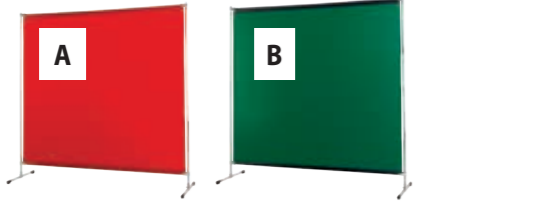

PRO



	A	B	C
mm	2000 x 2000	2000 x 2000	2000 x 2150
mm	0,4	0,4	0,4
rollers	—	—	OK
ref	060227 170,00 € HT	060463 170,00 € HT	060470 381,00 € HT

KITS DE PROTECTION - Protection kits - Schweißerschutzkit



Lot de 1^{er} Équipement du soudeur - Starter welding kit - Schweißerskit für Einsteiger
070493 **22,00 € HT**

Lot Équipement professionnel du soudeur - Professional kit - Profi-Schweißerskit
070561 **36,00 € HT**

COUVERTURE ANTI-CHALEUR - Heat protection cover - Hitzeschutzdecke - Manta anti-calor



	PROTEC 550	PROTEC 1200	PROTEC 1300	PROTEC 1300L
Protection	M0	M0	M0	—
t°	550°C/1000°F	1200°C/2200°F	1300°C/2400°F	1300°C/2400°F
mm	2000 x 2000	1750 x 1500	2000 x 1800	2000 x 1800
g/m²	580	1200	620	420
ref	050495 70,00 € HT	050204 175,00 € HT	053595 178,00 € HT	060500 156,00 € HT

MAGNET - Magnethalterung



(x2) 052291 **60,00 € HT**

LUNETTES DE PROTECTION - Protection goggles - Schutzbrillen

Antiprojection/meulage - Anti-projection/grinding
Anti-proyección/amoladura - Spritzschutz/Schleifen



EN 166

Shade/IRS 042841 **27,00 € HT**

Shade/IRS 042821 **5,10 € HT**

Shade/IRS 047778 **26,10 € HT**

Shade/IRS 047792 **26,10 € HT**

Shade/IRS 047839 **28,00 € HT**

CASQUE DE CHANTIER - Hard hat - Schutzhelm



Shade/IRS EN 397/352-3/166 064218 **62,30 € HT**

-23dB

adjustable Ø 55>62 cm

SOUDURE CHALUMEAU - Torch welding - Autogenschweißen



Shade/IRS 042803 **9,30 € HT**

Shade/IRS 042858 **10,30 € HT**

CAGOLE TEXTILE DE PROTECTION - Fireproof hood - Textil-Schweißer-schutzhaube - Máscara de protección



EN ISO 11611 EN 1149-5 (A1, B1, C1, F1) 037687 **32,40 € HT**

EN 470 EN 11611 CLASS 1 ISO 15025: CLASS 1 045224 **26,30 € HT**

EN ISO 11611 Class 1/A1+A2 064195 **20,30 € HT**

GANTS DE SOUDAGE - Welding gloves - Schweißhandschuhe - Guantes

TIG

BASIC
Gants PRO TIG - T10 045194 **11,30 € HT**

EN 388 2122
EN 407 422X4X EN12477 Class : A1

PRO
Gants PRO TIG EXTRA - T10 045323 **13,30 € HT**

EN 388 2111XX
EN 407 41313X EN12477 Class : A1

EXPERT
Gants de soudage renforcés - Reinforced welding gloves
T9: 064164 **24,00 € HT** T9.5: 064171 **24,00 € HT**

EN 388 2111XX
EN 12477 TYPE B
EN 407 412X4X EN12477 Class : A1

MMA - MIG/MAG

BASIC
Heavy Duty - T10 (MMA - MIG - Plasma) 045101 **9,30 € HT**

EN 388 4244
EN 407 423X4X EN12477 Class : A1

PRO
Gants de soudage renforcés - T10 - Reinforced welding gloves 045873 **13,30 € HT**

EN 388 4244
EN 407 423X4X EN12477 Class : A1

Bouclier protection de main en fibre de verre - High heat reflective fiber glass handshield with leather back - Hochhitze-fester Handschutz mit Glasfaser und Leder rückseite
20 x 15 cm
064157 **17,30 € HT**

GANTS DE MANUTENTION / MEULAGE - Handling gloves - Handschuhe - Guantes

Anti coupeure - Anti-cut T9 045897 **11,30 € HT**

EN 388 4342

✓ écran tactile - touch screen friendly

Anti coupeure haute résistance High resistance anti-cut EN 420 EN 388:4121
T9: 045910 **42,00 € HT**
T10: 045927 **42,00 € HT**

Anti coupeure haute dextérité - High dexterity anti-cut EN 420 EN 388:1121
T9: 045903 **39,30 € HT**
T10: 045934 **39,30 € HT**

T10 064188 **12,30 € HT**

EN 420 2003 +A1

Ultra Flexible

EN 388 2011 X

CHAUSSURES - Shoes

0% metal
EN ISO 20345 S3 HI HRO SRC



40 064225 **111,00 € HT**
41 064232 **111,00 € HT**
42 064249 **111,00 € HT**
43 064256 **111,00 € HT**
44 064263 **111,00 € HT**
45 064270 **111,00 € HT**

VESTES - Jackets - Jacke

EN ISO 11611 Class 2-A1



Cuir Leather Leder

XL (52/54) 037663 **67,30 € HT**

IEC 61482-2 Class 1-4kA
EN ISO 11612 A1+A2-B1-C1-E3-F1
EN ISO 11611 Class 2-A1 & A2
EN 1149-5



98% cotton, 2% antistatic

S (40/42) 046313 **96,30 € HT** XL (52/54) 046344 **96,30 € HT**
M (44/46) 046320 **96,30 € HT** XXL (56/58) 046351 **96,30 € HT**
L (48/50) 046337 **96,30 € HT**

EN ISO 11612 A1+B1-C1-E1-F1
EN ISO 11611 A1 Class 1
IEC 61482-2 Class 1
EN 13034 A1 Type 6
EN 1149-5



74% cotton, 25% polyester, 1% carbon — 330 g/m²

S (T.2) 073760 **206,00 € HT** XL (T.5) 073791 **206,00 € HT**
M (T.3) 073777 **206,00 € HT** XXL (T.6) 073807 **206,00 € HT**
L (T.4) 073784 **206,00 € HT**

NEW

PRO

TABLIER CUIR MULTI-USAGE - Multi-use leather apron - Delantal de cuero multi-uso - Mehrzweck-Lederschürze



EN ISO 11611 Class 2-A1

045200 **18,30 € HT**

045217 **38,00 € HT**

MANCHETTES DE SOUDEUR - Welding sleeves - Schweißärmel - Mangas protectoras



450 mm

400 mm

045231 **24,00 € HT**

037670 **24,00 € HT**

PANTALON - Trousers - Hose



EN ISO 11612 A1+A2-B1-C1-E3-F1
EN ISO 11611 Class 2-A1 & A2
IEC 61482-2 Class 1-4kA
EN 1149-5
EN 14404 +A1 Type 2

98% cotton, 2% antistatic

S (40/42) 046368 **90,00 € HT**
M (44/46) 046375 **90,00 € HT**
L (48/50) 046382 **90,00 € HT**
XL (52/54) 046399 **90,00 € HT**
XXL (56/58) 046412 **90,00 € HT**

HELMETS TECHNOLOGIES

	Intensity (A)														
	1.5	70	100	125	150	175	200	225	250	300	350	400	450	500	600
TIG	8	9	10			11		12	13						
MAG	8	9	10			11		12					13		
MIG			9	10		11		12	13	14					
MIG light alloys				10		11		12	13	14					
PLASMA			9	10	11	13									



Teinte initiale - Initial shade

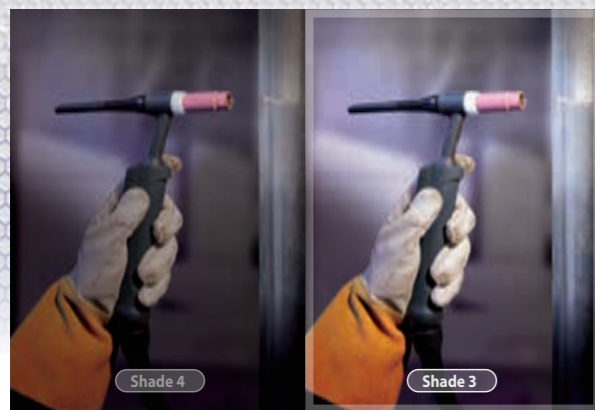

Classic

ULTRA CLEAR



Spectre de couleur - Spectrum view

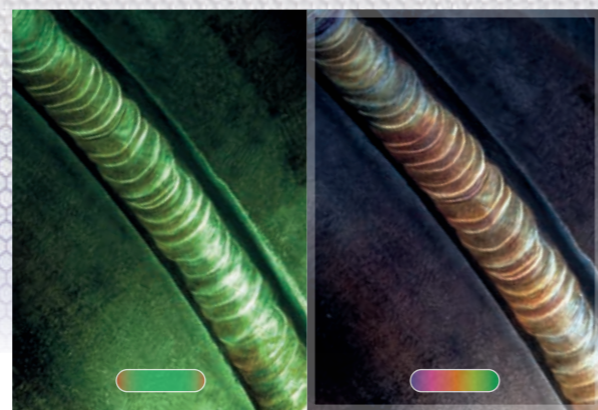

Classic

TRUECOLOR



Capturs sensibles - Sensitivity sensors

Classic

HIGH SENSIBILITY



Sensors x2

Sensors x4

Sensors x7



Classification EN379 - X=/X=/X=/X=

1/1/1/1 = PERFECT QUALITY

(1) Qualité optique (distorsion). (2) Diffusion de la lumière (contraste). (3) Variation de la transmission lumineuse (homogénéité de la teinte foncée). (4) Lumière angulaire (filtre de rayons lumineux diagonaux).

(1) Optical quality (distortion). (2) Light diffusion (contrast). (3) Variation of light transmission (homogeneity of the dark shade). (4) Angular light (diagonal light ray filter).

(1) / (2) / (3) / (4)



Serre-tête - Headgear



Simple

Multi

MULTI PRO

MULTI PREMIUM

Comfortable back

MULTI PREMIUM PRO

Comfortable back / Perfect stability

MANUAL

11



Masque pliable - Foldable mask - Faltbare leder-Schutzmaske
064201
38,60 €HT



Verres - Lenses - Schutzläser
042605 3,00 €HT



HAND MASK 11
042209 10,10 €HT



Manual
FLIP FLAP 0/11
042513 19,00 €HT



HELMETS

11

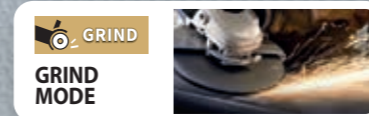

LCD TECHNO 11
064997 35,60 €HT

◀ 98 x 35 mm | □ ▶ 0.6 ms

TRUECOLOR

LCD MASTER 11
043442 39,40 €HT

◀ 100 x 49 mm | □ ▶ 0.5 ms

TRUECOLOR



LCD SPACE 11
TRUECOLOR
062245 70,60 €HT

◀ 100 x 49 mm | □ ▶ 0.5 ms

TRUECOLOR



LCD EXPERT 11
CARBON
040755 59,40 €HT

◀ 100 x 49 mm | □ ▶ 0.5 ms

TRUECOLOR



LCD INVADER 11
TRUECOLOR
062252 65,00 €HT

◀ 100 x 49 mm | □ ▶ 0.5 ms

TRUECOLOR

HELMETS

9-13



◀ 98 x 43 mm

□ ▶ 0.3 ms



HERMÈS SILVER
040908 78,80 €HT

HERMÈS RED
040885 78,80 €HT

HERMÈS GOLD
040892 78,80 €HT

VERRES - Lenses - Schutzgläser	1	2	3	4	5	6	7	8	9	10	11	12	13	14	15	16	17	18	19	20	21	22	23	24	25	26	27	28	29	30	31	32	33	34	35	36	37	38	39	40	41	42	43	44	45	46	47	48	49	50	51	52	53	54	55	56	57	58	59	60	61	62	63	64	65	66	67	68	69	70	71	72	73	74	75	76	77	78	79	80	81	82	83	84	85	86	87	88	89	90	91	92	93	94	95	96	97	98	99	100
105x50 (x50)	042629	8,50 €HT	105x50 (x50)	042643	14,10 €HT	HANDMASK 11	11	—	—	—	—	—	92x36 mm	■	—	—	—	—	—	—	—	—	—	—	400 g	Gys																																																																										
110x90 (x5)	040816	4,80 €HT	110x90 (x5)	040762	7,90 €HT	FLIP FLAP 0/11	11	—	—	—	—	—	97x80 mm	■	—	—	—	—	—	—	—	—	—	Simple	425 g	Gys																																																																										
110x90 (x5)	040816	4,80 €HT	102x40 (x5)	040830	3,30 €HT	LCD TECHNO 11	3>11	■	0.60 ms	0.35 ms	1/1/1/1	98x35 mm	—	—	☀	—	—	—	—	—	—	—	Simple	420 g	Gys																																																																											
110x90 (x5)	040816	4,80 €HT	104x55 (x5)	040847	3,90 €HT	LCD MASTER 11	3>11	■	0.50 ms	0.35 ms	1/1/1/1	100x49 mm	—	—	☀	—	—	—	—	—	—	—	Simple	400 g	Gys																																																																											
392x117 (x3)	065215	9,80 €HT	103.6x54 (x5)	040809	3,90 €HT	LCD SPACE 11 TRUECOLOR	3>11 + 2x:5	■	0.50 ms	0.35 ms	1/1/1/1	100x49 mm	—	✓	☀	—	—	—	—	—	—	—	Multi	470 g	Gys																																																																											
119x98 (x5)	040823	5,10 €HT	104x55 (x5)	040847	3,90 €HT	LCD EXPERT 11 CARBON	3>11	■	0.50 ms	0.35 ms	1/1/1/1	100x49 mm	—	—	☀	—	—	—	—	—	—	—	Simple	480 g	Gys																																																																											
110x90 (x5)	040816	4,80 €HT	103.6x54 (x5)	040809	3,90 €HT	LCD INVADER 11 TRUECOLOR	3>11	■	0.50 ms	0.35 ms	1/1/1/1	100x49 mm	—	✓	☀	—	—	—	—	—	—	—	Multi	480 g	Gys																																																																											
115x102 (x5)	040793	5,20 €HT	103.6x54 (x5)	040809	3,90 €HT	HERMES	4-9>13	—	0.30 ms	0.10>1 s	1/1/1/3	98x43 mm	■	—	☀ + 2 (CR 2032)	—	—	—	—	—	—	—	Simple	520 g	Toolit																																																																											

HELMETS

9-13



◀ 98 x 43 mm

☐ → ■ 0.3 ms



**EXPERT 9/13 G
CARBON**
040878 **76,30 € HT**



EXPERT 9/13 G
042216 **76,30 € HT**

◀ 92 x 42 mm

☐ → ■ 0.1 ms



LCD TECHNO 9/13
065048 **61,30 € HT**



◀ 92 x 42 mm

☐ → ■ 0.1 ms



**LCD VENUS 9/13 G
IRON TRUECOLOR**
064980 **70,60 € HT**



**LCD VENUS 9/13 G
BONES TRUECOLOR**
064973 **70,60 € HT**



**LCD VENUS 9/13 G
TRUECOLOR**
064966 **70,60 € HT**

HELMETS

5-9/9-13



◀ 100 x 49 mm

☐ → ■ 0.1 ms



**PROMAX 9/13 G
VOLCANO**
037205 **86,30 € HT**



**PROMAX 9/13 G
SHARK**
037199 **86,30 € HT**



**PROMAX 9/13 G
SILVER**
045774 **80,00 € HT**



◀ 100 x 67 mm

☐ → ■ 0.1 ms



**ZEUS 5-9/9-13 G
INDIAN**
038332 **98,80 € HT**



**ZEUS 5-9/9-13 G
FIRE**
044098 **98,80 € HT**



**ZEUS 5-9/9-13 G
COSMIC**
044104 **98,80 € HT**

IDEAL

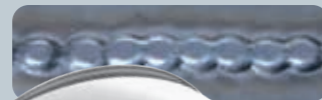

LCD GYSMATIC 9/13 G AIR TRUECOLOR

065727 **606,00 € HT**

Filtration
class EN 12941 :
TH2 P R SL

Air 165 / 200 / 220 L/min
Battery included

OPTION Filter
TH3
065734
31,60 € HT



Battery charger
037472 **22,80 € HT**
Ref. 028869

Battery included
037465 **120,00 € HT**

038424 **28,10 € HT**

038417 **6,80 € HT**



**LCD FIREMAN 9-13
TRUECOLOR**
062269 **91,90 € HT**



**LCD GYSMATIC 9/13 G
TRUECOLOR**
043909 **145,00 € HT**

◀ 100 x 49 mm | ☐ → ■ 0.1 ms

◀ 100 x 60 mm | ☐ → ■ 0.08 ms

OPTIONS

Sac pour masque de soudage
- Carry bag for helmet welding



043299 **8,80 € HT**



066656 **16,80 € HT**



Bandeau anti-transpiration
- Antiperspirant - headband

043466 **5,30 € HT**
for Simple, Multi, Multi
Premium, Multi Premium Pro
062627 **5,30 € HT**
for Multi Pro
070844 **5,30 € HT**
(x 1) for
Gysmatic 5/13 Air XXL

Loupe
- Magnifying
glass (x1)

zoom x2
042780 **4,80 € HT**
zoom x3
042781 **6,80 € HT**

VERRES
- Lenses
- Schutzgläser

	☐ → ■	☐ → ■	☐ → ■	☐ → ■	☐ → ■	☐ → ■	☐ → ■	☐ → ■	☐ → ■	☐ → ■	☐ → ■	☐ → ■	☐ → ■	☐ → ■	☐ → ■	☐ → ■	☐ → ■	☐ → ■	☐ → ■	☐ → ■	☐ → ■	☐ → ■	☐ → ■	☐ → ■	☐ → ■	☐ → ■	☐ → ■	☐ → ■	☐ → ■	☐ → ■	☐ → ■	☐ → ■	☐ → ■	☐ → ■					
111x91 (x5)	063723	5,80 € HT	103.6 x 54 (x5)	040809	3,80 € HT	EXPERT 9/13 G	4-9>13	—	0.30 ms	—	0.10>1 s	1/1/1/3	2	98x43 mm	☑	☐ → ■	☐ → ■	☐ → ■	☐ → ■	☐ → ■	☐ → ■	☐ → ■	☐ → ■	☐ → ■	☐ → ■	☐ → ■	☐ → ■	☐ → ■	☐ → ■	☐ → ■	☐ → ■	☐ → ■	☐ → ■	☐ → ■	☐ → ■				
110x90 (x5)	040816	4,80 € HT	95.5 x 50.5 (x5)	040854	3,80 € HT	LCD TECHNO 9/13	4-9>13	☐ → ■	0.10 ms	—	0.10>0.8 s	1/2/1/1	2	92x42 mm	—	☐ → ■	☐ → ■	☐ → ■	☐ → ■	☐ → ■	☐ → ■	☐ → ■	☐ → ■	☐ → ■	☐ → ■	☐ → ■	☐ → ■	☐ → ■	☐ → ■	☐ → ■	☐ → ■	☐ → ■	☐ → ■	☐ → ■	☐ → ■	☐ → ■	☐ → ■		
226 x 106 (x5)	045781	8,10 € HT	103.6 x 54 (x5)	040809	3,80 € HT	LCD FIREMAN 9-13 TRUECOLOR	3-9>13	☐ → ■	0.10 ms	—	0.10>0,8 s	1/1/1/2	2	100x49 mm	☑	☐ → ■	☐ → ■	☐ → ■	☐ → ■	☐ → ■	☐ → ■	☐ → ■	☐ → ■	☐ → ■	☐ → ■	☐ → ■	☐ → ■	☐ → ■	☐ → ■	☐ → ■	☐ → ■	☐ → ■	☐ → ■	☐ → ■	☐ → ■	☐ → ■	☐ → ■	☐ → ■	
114x133 (x10)	043893	12,80 € HT	G: 106 x 66 (x10)	043886	6,80 € HT	LCD GYSMATIC 9/13 G TRUECOLOR	4-9>13	☐ → ■	0.08 ms	☑	0.10>0.90 s	1/1/1/2	4	XL: 100x60 mm	☑	☐ → ■	☐ → ■	☐ → ■	☐ → ■	☐ → ■	☐ → ■	☐ → ■	☐ → ■	☐ → ■	☐ → ■	☐ → ■	☐ → ■	☐ → ■	☐ → ■	☐ → ■	☐ → ■	☐ → ■	☐ → ■	☐ → ■	☐ → ■	☐ → ■	☐ → ■	☐ → ■	
110x90 (x5)	040816	4,80 € HT	95.5 x 50.5 (x5)	040854	3,80 € HT	LCD VENUS 9/13 G TRUECOLOR	3-9>13	☐ → ■	0.10 ms	—	0.10>0.8 s	1/1/1/2	2	92x42 mm	☑	☐ → ■	☐ → ■	☐ → ■	☐ → ■	☐ → ■	☐ → ■	☐ → ■	☐ → ■	☐ → ■	☐ → ■	☐ → ■	☐ → ■	☐ → ■	☐ → ■	☐ → ■	☐ → ■	☐ → ■	☐ → ■	☐ → ■	☐ → ■	☐ → ■	☐ → ■	☐ → ■	☐ → ■
226x106 (x5)	045781	8,10 € HT	103.6 x 54 (x5)	040809	3,80 € HT	PROMAX 9/13 G	4-5>9/9>13	☐ → ■	0.10 ms	—	0.10>0.8 s	1/1/1/2	2	100x49 mm	☑	☐ → ■	☐ → ■	☐ → ■	☐ → ■	☐ → ■	☐ → ■	☐ → ■	☐ → ■	☐ → ■	☐ → ■	☐ → ■	☐ → ■	☐ → ■	☐ → ■	☐ → ■	☐ → ■	☐ → ■	☐ → ■	☐ → ■	☐ → ■	☐ → ■	☐ → ■	☐ → ■	☐ → ■
114 x 133 (x10)	043893	12,80 € HT	103.7 x 69.5 (x5)	043695	4,80 € HT	ZEUS	4-5>9/9>13	☐ → ■	0.10 ms	—	0.15>0.8 s	1/1/1/2	4	XL: 100x67 mm	☑	☐ → ■	☐ → ■	☐ → ■	☐ → ■	☐ → ■	☐ → ■	☐ → ■	☐ → ■	☐ → ■	☐ → ■	☐ → ■	☐ → ■	☐ → ■	☐ → ■	☐ → ■	☐ → ■	☐ → ■	☐ → ■	☐ → ■	☐ → ■	☐ → ■	☐ → ■	☐ → ■	☐ → ■

HELMETS

5-9/9-13



ERGOTECH +
5-9/9-13 DREAM
068674 126,00 €HT



ERGOTECH +
5-9/9-13 SILVER
068650 126,00 €HT



ERGOTECH +
5-9/9-13 BLACK
068667 126,00 €HT



Sensors x4



ALIEN +
TRUECOLOR XXL
068698 178,00 €HT

◀ 100 x 67 mm | **+** 0.1 ms | GRIND | **+**

ULTRA CLEAR 3 | CLASS 1/1/1/1 | TRUECOLOR

◀ 100 x 90 mm | **+** 0.1 ms | GRIND | **+**

ULTRA CLEAR 3 | CLASS 1/1/1/1 | TRUECOLOR



GYSMATIC XL
TRUECOLOR
037908 185,00 €HT

◀ 100 x 60 mm | **+** 0.08 ms

GRIND | **+** | CLASS 1/1/1/1 | TRUECOLOR

GYSMATIC XXL
TRUECOLOR
037236 248,00 €HT

◀ 100 x 83 mm | **+** 0.1 ms

GRIND | **+** | CLASS 1/1/1/1 | DIGITAL | TRUECOLOR

GYSMATIC 5/13 AIR XXL
TRUECOLOR
047846 725,00 €HT
028852



Filtration class
EN 12941 : TH2 P R SL
Air 165 / 200
220 L/min
Battery included

OPTION
Filter TH3
065734 31,00 €HT

- Battery charger 037472 22,00 €HT 028869
- Battery included 037465 120,00 €HT
- 038424 x1 28,00 €HT
- 038417 x5 6,00 €HT

◀ 100 x 67 mm | **+** 0.1 ms

GRIND | **+** | CLASS 1/1/1/1 | PANORAMIC | TRUECOLOR

PANORAMIC VIEW

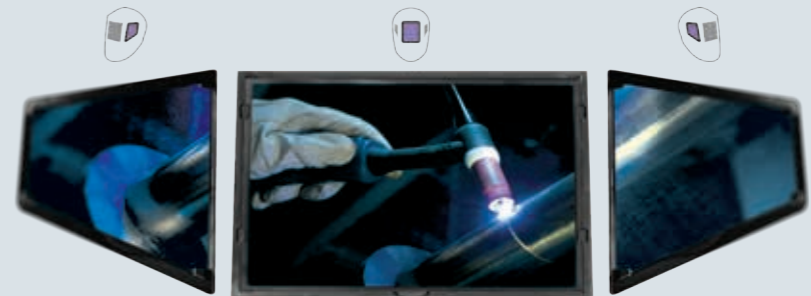

APOLLO+ 5-9/9-13 G
TRUECOLOR

Fixed DIN 5

◻ → ◼ DIN 3 › 5/13 Adjustable

Fixed DIN 5

PANORAMIC 3XL
TRUECOLOR

◻ → ◼ DIN 3 › 10

◻ → ◼ DIN 3 › 4/12 Adjustable

◻ → ◼ DIN 3 › 10



APOLLO+ 5-9/9-13 G
TRUECOLOR
068681 131,00 €HT

◀ 100 x 67 mm | **+** 0.1 ms

GRIND | **+** | CLASS 1/1/1/1 | PANORAMIC | TRUECOLOR

Fixed shade 5 | 4-5-9/9-13 Adjustable | Fixed shade 5



PANORAMIC 3XL
TRUECOLOR
037281 333,00 €HT

◀ 114 x 85 mm | **+** 0.15 ms

GRIND | **+** | CLASS 1/1/1/1 | ULTRA CLEAR 3 | TRUECOLOR

Shade 3-10 | 3-4-8/8-12 Adjustable | Shade 3-10

OPTIONS

Sac pour masque de soudage - Carry bag for helmet welding



066656 16,00 €HT

Bandeau anti-transpiration - Antiperspirant - headband

043466 5,00 €HT for Simple, Multi, Multi Premium, Multi Premium Pro
062627 5,00 €HT for Multi Pro
070844 5,00 €HT (x1) for Gysmatic 5/13 Air XXL



Loupe - Magnifying glass (x1)

zoom x2 042780 4,00 €HT
zoom x3 064140 6,00 €HT

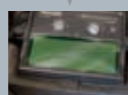

VERRES - Lenses - Schutzgläser

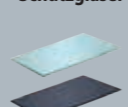

							TRUE COLOR	◻ → ◼	◻ → ◼	◻ → ◼	⌚	⌚	⌚	⌚	⌚	⌚	⌚	⌚	⌚	MASK BRAND
114 x 133 (x10)	043893 12,00 €HT	103.7 x 69.5 (x5)	043695 4,00 €HT	ERGOTECH +	3-5 > 9 / 9 > 13	■	0.10 ms	—	0.15 > 0.8 s	1/1/1/1	4 HIGH SENSITIVITY	XL: 100x67 mm	■	☀ + 2 ⌚ (CR 2450)	Multi Premium	580 g	Gys			
114 x 133 (x10)	043893 12,00 €HT	104 x 96 (x5)	043596 4,00 €HT	ALIEN + XXL TRUECOLOR	3-5 > 9 / 9 > 13	■	0.10 ms	✓	0.15 > 0.8 s	1/1/1/1	4 HIGH SENSITIVITY	XXL: 100x90 mm	■	☀ + 2 ⌚ (CR 2032)	Multi Premium	560 g	Gys			
110 x 90 (x5)	040816 4,80 €HT	106 x 66 (x10)	043886 6,00 €HT	GYSMATIC XL TRUECOLOR	4-5 > 9 / 9 > 13	■	0.08 ms	✓	0.1 > 0.9 s	1/1/1/1	4 HIGH SENSITIVITY	XL: 100x60 mm	■	☀ + 2 ⌚ (CR 2450)	Simple	540 g	Gys			
114 x 133 (x10)	043893 12,00 €HT	106 x 89.5 (x10)	046825 9,00 €HT	GYSMATIC 5/13 AIR XXL TRUECOLOR	4-5 > 9 / 9 > 13	■	0.10 ms	✓	0.1 > 0.9 s	1/1/1/1	4 HIGH SENSITIVITY	XXL: 100x83 mm	■	☀ + 2 ⌚ (CR 2450)	Simple	680 g	Gys			
				GYSMATIC XXL TRUECOLOR											Multi Pro					
114 x 133 (x10)	043893 12,00 €HT	103.7 x 69.5 (x5)	043695 4,00 €HT	APOLLO+ 5-9/9-13 G	3-5 > 9 / 9 > 13 + 2x:5	■	0.10 ms	—	0.15 > 0.8 s	1/1/1/1	4 HIGH SENSITIVITY	XL: 100x67 + 2x103.7x69.5 mm	■	☀ + 2 ⌚ (CR 2450)	Multi Premium	580 g	Gys			
390 x 150 (x3)	037311 11,00 €HT	special kit (x1)	037304 12,00 €HT	PANORAMIC 3XL TRUECOLOR	3-4 > 8 / 8 > 12 + 2x:3 > 10	■	0.15 ms	✓	0.15 > 0.8 s	1/1/1/1	4 HIGH SENSITIVITY	114x85 + 2x(68x80) mm	■	☀ + 2 ⌚ (CR 2450)	Multi	610 g	Gys			

HELMETS

4-8/8-13



WORKING LIGHT



GYSMATIC EXPLORER 3
TRUECOLOR
068728 **284,00 €HT**

◀ 130 x 58 mm | ▶ 0.05 ms

GRIND DIGITAL ULTRA CLEAR 3

CLASS 1/1/1/2 TRUECOLOR



GYSMATIC FLIP-FLAP GOGGLE 3
TRUECOLOR
068711 **381,00 €HT**

◀ 130 x 58 mm | ▶ 0.05 ms

GRIND DIGITAL ULTRA CLEAR 3

CLASS 1/1/1/1 TRUECOLOR

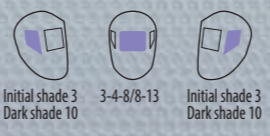

EXCLUSIVE FOR PROFESSIONAL

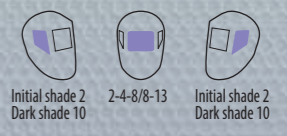

GYSMATIC GOGGLE 3
TRUECOLOR
068704 **381,00 €HT**

◀ 130 x 58 mm | ▶ 0.1 ms

GRIND DIGITAL ULTRA CLEAR 3

PANORAMIC CLASS 1/1/1/1 TRUECOLOR



GYSMATIC XXL 2.0
TRUECOLOR
069138 **383,00 €HT**

◀ 100 x 93 mm | ▶ 0.06 ms

GRIND DIGITAL ULTRA CLEAR 2

PANORAMIC CLASS 1/1/1/2 TRUECOLOR

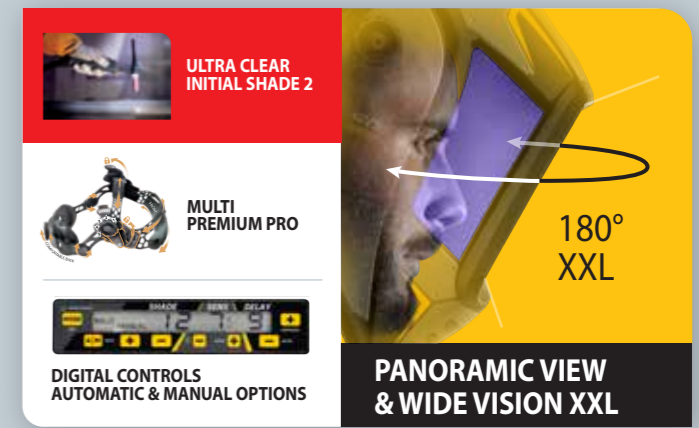

OPTIONS



							TRUE COLOR	HF	DELAY									MASK BRAND
170.12 x 56.66 (x10)	071049 20,00 €HT	127.4 x 37.4 (x10)	071032 5,00 €HT	GYSMATIC EXPLORER 3	3 - 4>8 / 8>13	■	0.05 ms	—	0.06 > 1.0 s	1/1/1/2	3	125x35 mm	■	—	✱ + 2 Ⓜ (CR 2032)	—	375 g	Gys
290 x 147.5 (x10)	071025 33,00 €HT	135.2 x 62.8 (x10)	071018 7,40 €HT	GYSMATIC FLIP-FLAP GOGGLE 3	3 - 4>8 / 8>13	■	0.05 ms	—	0.06 > 1.0 s	1/1/1/1	3	XL : 138x58 mm	■	—	✱ + 2 Ⓜ (CR 2032)	Multi Premium Pro	578 g	Gys
385.8 x 137.7 (x10)	070998 41,00 €HT	133.5 x 60.4 (x10)	070981 7,40 €HT	GYSMATIC GOGGLE 3	3 - 4>8 / 8>13	■	0.10 ms	✓	0.06 > 0.10 s	1/1/1/1	7 HIGH SENSITIVITY	XXL : 130x58 mm + 2x 52x48 mm	■	—	✱ + 2 Ⓜ (CR 2450)	Multi Premium Pro	580 g	Gys
122.7 x 146.5 (x10)	075580	103.8 x 95.8 (x10)	075597	GYSMATIC XXL 2.0	2 - 4>8 / 8>12	■	0.06 ms	—	0.06 > 0.12 s	1/1/1/2	5 HIGH SENSITIVITY	XXL : 100x90 mm + 2x 105x40 mm	■	■	✱ + 2 Ⓜ (CR 2450)	Multi Premium Pro	578 g	Gys

LAMPE BALADEUSE - Hand Lamp - Handleuchte

100-250 lumens (x3)

TRIPODE 250 L

3 x 1 W COB LED

3 x 3.6 V - 300 mAh
AAA rechargeable, Ni-MH
USB charging (6h)
USB power supply

operating time
High position: 1 h
Low position: 3 h
Flashing: 5 h

↳ 260 x 100 x 100 mm

059955 **51.00 € HT**



400 lumens

400 L

COB LED

Li-ion
Charging time: 8h
USB power supply

operating time
High position: 2.5 h
Low position: 5 h
Top light (1 W): 6 h

↳ 230 x 65 x 40 mm

059153 **42.00 € HT**



200-400 lumens

ÉTANCHE 400 L

COB LED

3.7 V - 2000 mAh Li-ion
USB charging only (4/6 h)

operating time
High position: 2 h
Mid position: 4 h
Top light (4 W): 3 h

↳ 285 x 65 x 65 mm

IP 56

059948 **51.00 € HT**

Étanche - Waterproof



250-600 lumens

PRO 600 L

COB LED, 80 CRI

3.7 V - 2200 mAh Li-ion
micro USB charging (3.5 h)
USB power supply

operating time:
High position: 1.5 h,
Mid position: 4.5 h,
Top light (100 lumens): 10 h

↳ 190 x 56 x 29 mm

IP 54

210 g

060883 **61.00 € HT**

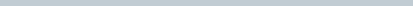

LAMPE INSPECTION - Inspection Lamp - Inspektionslampe

120-200 lumens

MINI 200 L

COB LED, 80 CRI, 6500 K

3.7 V - 700 mAh Li-ion
micro USB charging only (2.5 h)

operating time
High position: 1.5 h
Low position: 4 h
Top light: 3.5 h

IP 20

↳ 76 g, ↳ 174 x 27.5 x 28 mm

060852 **33.00 € HT**



100-280 lumens

FRONTALE 280 L

3 W COB LED
80 CRI+
6500 K

3.7 V - 1500 mAh Li-po
micro USB charging only

operating time
High position: 2 h
Low position: 6 h

IP 65

↳ 110 g, ↳ 78.5 x 47.5 x 42 mm

060845 **40.00 € HT**



motion
detection
mode

50-500 lumens

FLEXIBLE 500 L

COB LED
80 CRI+
6500 K

3.7 V - 2600 mAh Li-ion
USB charging (4 h)
USB power supply

operating time
High position: 2 h
Low position: 16 h
Top light: 9.5 h

IP 54

↳ 290 g, ↳ 423 x 65.5 x 44.5 mm

060869 **63.00 € HT**



0-600 lumens

PRO 600 L

COB LED
6500 K

3.7 V - 2600 mAh Li-ion
USB power supply

operating time
1.5 > 15 h

↳ 380 x 40 x 45 mm

300 g

057760 **66.00 € HT**

058309



LAMPE AMBIANCE 360° - 360° ambient lamp

60-1000 lumens

1000 L
>80 CRI SMD LED
6500 K

3.7 V - 5200 mAh Li-ion
USB charging (4.5h)
USB power supply

operating time 2 > 27 h

↳ 260 x 75 x 75 mm

IP 54

450 g

059764 **92.00 € HT**



LAMPE SOUS CAPOT - Under bonnet lamp - Leuchte für Motorhaube

Under bonnet lamp
Leuchte für Motorhaube

500-1000 lumens

600 L

120 COB LED

3.7 V - 4000 mAh Li-ion
charging time: 10/12 h
Power supply charger

operating time
High position: 4 h
Low position: 8 h

1.7 kg

059962 **103.00 € HT**

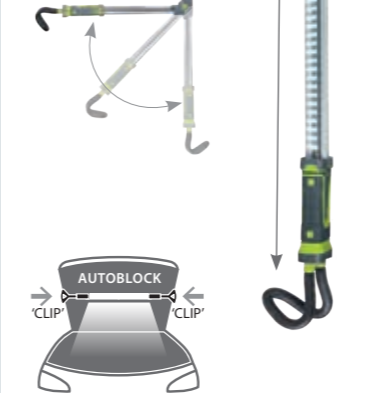

250-800 lumens

800 L

120 COB LED

3.7 V - 4000 mAh Li-ion
charging time: 10/12 h
Power supply charger

operating time
High position: 3 h
Low position: 6 h

058002 **96.00 € HT**

058316

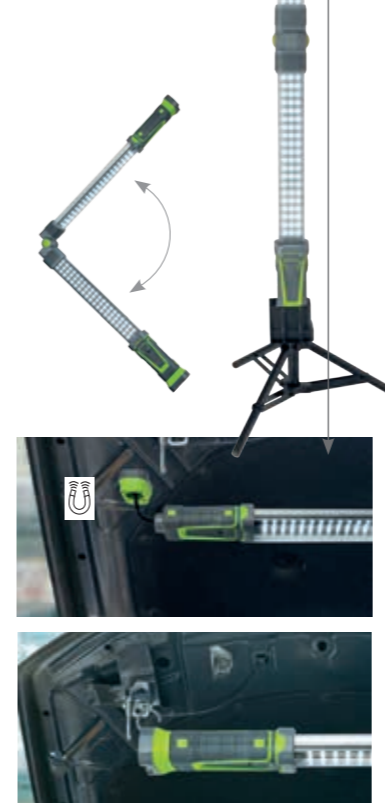

PROJECTEUR SUR TRÉPIED - Worklight with tripod - Arbeitsleuchte mit Standfuß

1800 lumens

1800 L

3 x 55 COB LED
total 165 LED

1.8 m power cord

059146 **106.00 € HT**

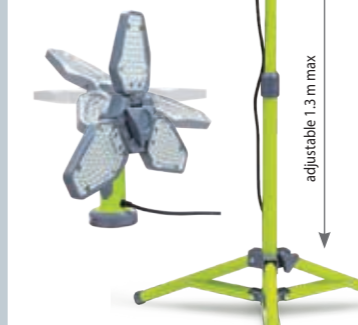

3000 lumens

3000 L

35 W COB LED

2 m power cord

IP 44

059979 **110.00 € HT**



4000 lumens

4000 L

3 x 20 COB LED,
total 60 LED

3 m power cord

059986 **160.00 € HT**

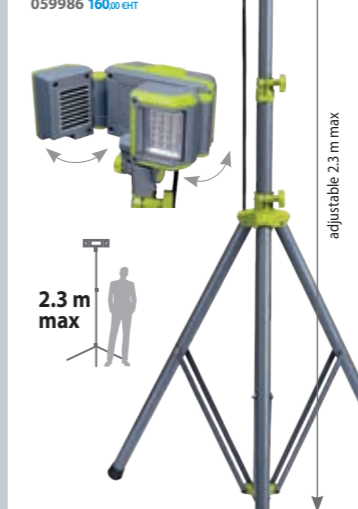

MARKETING



107

Podium de présentation
- Display stand
- Podest

PODIUM 2
A: 80 cm
B: 50 cm
C: 50 cm
063211 **278.00 € HT**

PODIUM 1
A: 45 cm
B: 50 cm
C: 50 cm
063204 **210.00 € HT**

Console
- Display
- Produkt-Aufsteller
(machines not included)

GYSMI 80P + 130P + 160P + E163
060203 **67.00 € HT**

GYSMI 130P + 160P + 200P + E163
060449 **67.00 € HT**

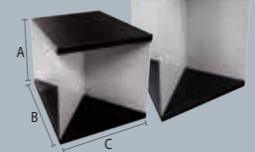

Petit présentoir
- Product Display - Geräte-Aufsteller
(machines not included)
060043 **288.00 € HT**



Linéaire de vente avec 2 étagères
- Retail display space with 2 shelves
- Lochwandregal mit 2 Böden
060784 **900.00 € HT**



Barnum 3 x 3 m

098022 **238.00 € HT**



Open barnum
2 x 2 m

098039 **126.00 € HT**



Oriflamme
- Banner
1,75 x 0,50 m
098015
56.00 € HT



Type	A	E	M
complet - complete	061002 3 969.00 € HT	061040 5 645.00 € HT	061026 5 052.00 € HT
- komplett			
sans linéaire - without display stand	061019 3 069.00 € HT	061057 5 083.00 € HT	061033 4 152.00 € HT
- ohne Inhalt			

more details :
www.gys.fr

WORKING LIGHTS
MARKETING



INVEST IN THE FUTURE



Fabricant français
depuis 1964

2
0
2
2
C

Soudage & Coupage



GYS FRANCE

SIÈGE SOCIAL

1 rue de la Croix des Landes
CS 54159
53941 Saint-Berthevin - Cedex
Laval - France
Tél +33 2 43 01 23 60
E-mail service.client@gys.fr



ZI, 134 bd des Loges
53941 Saint-Berthevin
Laval - France

CENTRE LOGISTIQUE

2 Rue Jean Dausset
53810 Changé - France
Tél +33 2 43 01 54 33



GYS GERMANY

Professor-Wieler
Straße 11
52070 Aachen
Deutschland

Tél +49 241/189-23-710
Fax +49 241/189-23-719
E-mail aachen@gys.fr



GYS UK

Unit 3 - Great Central Way
Rugby - Warwickshire
CV21 3XH
United Kingdom

Tél +44 1926 338 609
Fax +44 1926 429 764
E-mail uk@gys.fr



GYS ITALIA

Vega - Parco Scientifico
Tecnologico di Venezia
Via Delle Industrie, 25/4
30175 Marghera - VE
Italia

Tél +39 041 53 21 565
E-mail italia@gys.fr



GYS IBÉRICA

Avenida Pirineos 31
Nave 9
San Sebastian de los Reyes
28703 Madrid
España

Tél +34 917 409 790
E-mail iberica@gys.fr



GYS CHINA

Lot N°15
6666 bd Songze
201706 Qingpu
Shanghai
China

Tél +86 6221 4461
Fax +86 5226 0067
www.gys-china.com.cn
E-mail
contact@gys-china.com.cn



LinkedIn
 Youtube
 WeChat
 Facebook
 Instagram

www.gys.fr

Distribué par

